

Ankylos®

# Laboratory Manual

## General prosthetic advice for Ankylos®

In order to obtain utmost benefit from the unique restorative features of the Ankylos implant system, please observe the following guidelines:

- Avoid occlusal overload, aim for initial infra-occlusion to ensure clearance of contacts in function.
- If possible, use B-implants or larger for single molar restorations.
- Use gingiva height 0.75 and 1.5 only if really necessary, and in correspondence with thin gingiva.
- Minimize the functional occlusal surface in buccal-lingual dimension to avoid lateral levers.
- Take adequate precautions to avoid occlusal overload in correspondence to any prosthetic cantilevers.
- Bear in mind the resilience of neighboring teeth when planning for single tooth restorations. Establish full contact on the implant crown only during maximal clenching ensuring an even load distribution on all teeth during maximum chewing force.
- Check for parafunctional habits. Consider changes during recall appointments.
- In case of any changes to the occlusal scheme in other areas, evaluate the consequences for the implant restoration and, if required, take appropriate measures.
- Advice for the dental laboratory: The abutment design must not be manipulated at the areas of the connection taper or adjacent to the sulcus.

Please read this manual carefully before using the system for the first time and always observe the clinical indications, directions and notes in the instructions for use of the system components and instruments.

Furthermore, we recommend that all users attend a training course specific to the system prior to first using a new implant system.

Some products may not be available in all countries.

Please contact your Dentsply Sirona Sirona Implants representative to obtain up to date information on the product range and on availability.

To improve readability for our customers, Dentsply Sirona Implants does not use \* or ™ in body copy. However, Dentsply Sirona Implants does not waive any right to the trademark and nothing herein shall be interpreted to the contrary.

## CONTENTS

### **Treatment planning**

Aspects of treatment planning	4
Conventional treatment planning	6
Computer-guided treatment planning	7

### **Prosthetic concept**

The prosthetic principle of Ankylos	8
Ankylos prosthetics navigator	11
Solutions for single-tooth restoration	12
Solutions for larger tooth gaps	14
Solutions for the edentulous jaw	16
Basic guidelines for soft tissue management	18

### **Ankylos® Balance C/ or /X**

Crowns and bridges on Ankylos Balance Anterior C/ or /X	20
---	----

### **Ankylos® Regular C/ or /X**

Crowns and bridges on Ankylos Regular C/ or /X	28
--	----

### **Ankylos® Balance Base Abutment C/**

Bar-supported overdentures and bridges, also CAD/CAM-fabricated, on Ankylos Balance Base Abutment C/	40
--	----

### **Ankylos® SynCone® C/**

Overdentures on Ankylos SynCone C/	64
------------------------------------	----

### **Ankylos® Snap Attachment® C/**

Overdentures on Ankylos Snap Attachment C/	78
--	----

### **Ankylos® Standard C/**

Crowns, bridges and bar-supported dentures on Ankylos Standard C/	82
---	----

### **Appendix**

	98
--	----

# Treatment planning

## Aspects of treatment planning

Precise planning for any implantological procedure in close coordination between practitioners and laboratory is the basic prerequisite for lasting therapeutic success. All suitable measures and alternatives that will fulfill the expectations of the patient in terms of function and esthetics of the implant prosthetic rehabilitation should be stipulated in the planning.

Today, along with conventional treatment planning, treatment can be planned using computer-guided facilities for three-dimensional “crown down” treatment with planning of the optimal implant placement from the point of view of the desired prosthetic restoration, both functionally and esthetically.



The basis of treatment planning is always a thorough discussion with the patient with a view towards determining the wishes and perceptions of the patient, excluding contraindications and clarifying matters thoroughly with the patient. Next, a complete general and specific medical history is taken and an intraoral diagnostic assessment is made with an analysis of the initial anatomical situation.

The following points should be taken into account:

- Medical history
- General diagnosis - elimination of contraindications
- Specialist consultation where there are risk factors
- Extensive intraoral diagnosis (PAR diagnosis, functional examination, reasons for tooth loss, assessment of the existing tooth replacement, radiological examination)

After all the diagnostic details have been submitted and evaluated, the treatment can be planned.

This comprises the following elements:

- Preprosthetic planning
- Surgical planning
- Schedule
- Cost projection

# Conventional treatment planning

## Preprosthetic planning

Preprosthetic planning with the dental technician is the most important factor for the esthetic and functional success of the implant procedure.

## Surgical planning

During preoperative planning it is very important to check that the height and width of the jawbone is sufficient for placement of the implant.

The target is the best possible, tooth-analog placement of the implants. During the first planning session with the patient situation impressions are made to be used as the base for laboratory-fabricated diagnostic aids.

A diagnostic wax-up of the planned prosthetic restoration is made.

A thermoformed splint with radiographic balls that can be accurately repositioned in the patient's mouth is prepared. It can be subsequently modified to a conventionally fabricated surgical template.

The width of the vestibular and oral lamellae should be at least 1.5 mm after implant placement. The position and direction of important anatomical structures such as the mental foramen or maxillary sinus must be determined by radiology.

Grafted regions must be confirmed to have completely regenerated to a mechanically stable state before preparation.

Planned prosthetic measures must be checked to ensure that they can actually be implemented with appropriate surgical procedures. All aspects of preprosthetic and surgical planning interact directly with one another. Every change in the preprosthetic planning will affect the surgical planning and vice versa. This will also include the number, diameter, lengths, positions and alignment of the implants.

The available bone volume and important anatomical structures are examined in an x-ray image, which is prepared with the laboratory-fabricated x-ray template with the radiographic balls in the patient's mouth. The dimensions of the intraoral structures can be calculated from the defined diameter of the radiographic balls, taking the magnification factors resulting from radiological processes into account.

The implant lengths are selected by placing the transparent radiographic template on the OPG. If desired, the x-ray analysis must consider a subcrestal implant position (note magnification scale).

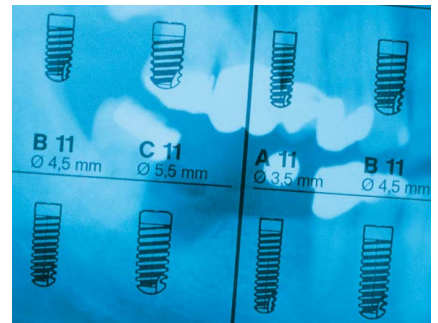

# Computer-guided treatment planning

Digital treatment planning based on three-dimensional imaging procedures enables the therapy to be planned with the highest accuracy and makes the result of the treatment safe and predictable.

Dentsply Sirona Implants offers a complete solution for digital treatment planning and full-guided implant placement based on the world-renowned Simplant software.

The advantages over conventional planning include:

- Safe three-dimensional planning in the sub-millimeter range and with reference to the desired restoration
- Automatic collision control, which displays too narrow clearances between implants or to the nerve
- Information on peri-implant bone quality for accurate conclusions on the expected primary stability

An individual Simplant drill guide is fabricated using stereolithography, based on the digital planning data. Depending on the individual case scenario, the guide is prepared tooth-supported, mucosa-supported or bone-supported, thus enabling a complete and accurate transfer to the patient's mouth.

The Sleeve-on-Drill drill system, drills with a guide sleeve that can be attached to the instrument for precise guidance in the template, has been especially developed for template-guided implant placement in order to facilitate accurate, straight-forward implant placement with the added security of the drill stop.

These enable simpler and precisely fitting placement of the implants with the reliability of the drill stop.

Simplant drill guides are also available with lateral access for easier management of the instruments, even with a restricted oral cavity.

Digital treatment planning with Simplant.

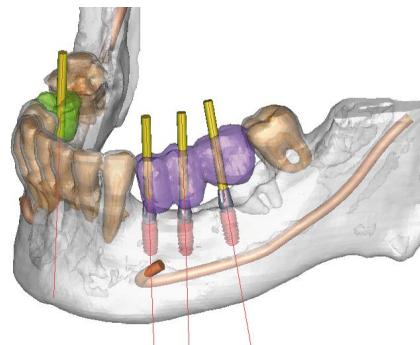

Patient-specific Simplant guide.



Sleeve-on-drill drill system and drill guide with lateral access.



# Prosthetic concept

## The prosthetic principle of Ankylos<sup>®</sup>

Ankylos implants are available in four diameters and in six lengths. This allows the surgeon to select the best possible implant according to the indication and the anatomical conditions.

Thanks to the geometry of the Ankylos TissueCare connection, identical for all implant diameters, you can provide each implant with all available prosthetic components and thus you can obtain the optimal prosthetic result, regardless of surgical requirements.

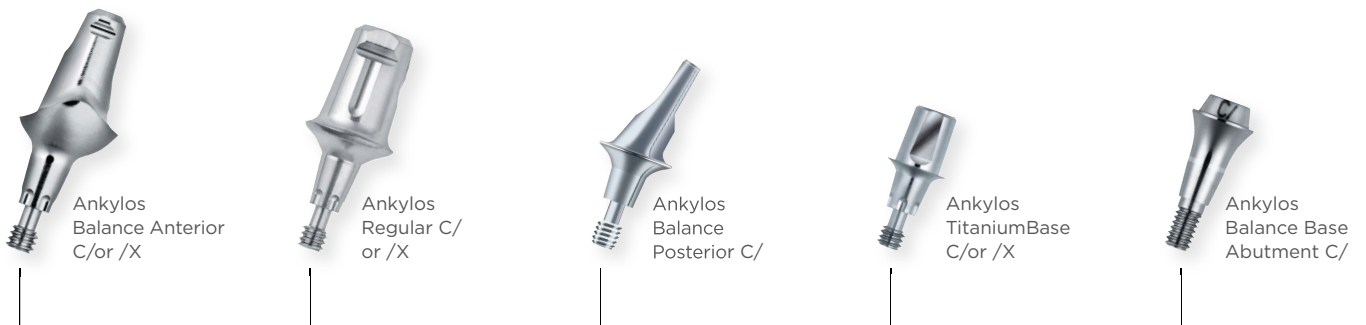



The Ankylos system includes a variety of prosthetics ranges from which you can choose depending on the indication and your preferred approach. Each range of prosthetics contains abutments in various sizes and forms, with and without positioning aid (index), if needed. Hence, a large variety of prosthetic conditions are provided, with the optimal functional and esthetic solution.

### One-fits-all connection

Thanks to the identical dimensions of the tapered connection, identical for all implant diameters, every Ankylos prosthetic abutment fits into every implant of any diameter. Hence, a decision as to the prosthetic strategy can still be made, even after implant healing or when the abutment is uncovered.

In fact, the compatibility of Ankylos prosthetic abutments offers further crucial advantages:

- The number of prosthetic parts required is markedly reduced, as compared with diameter-specific abutment concepts
- The diameter and length of the implant is solely selected commensurate with the bone volume
- The abutment is only selected in keeping with prosthetic requirements

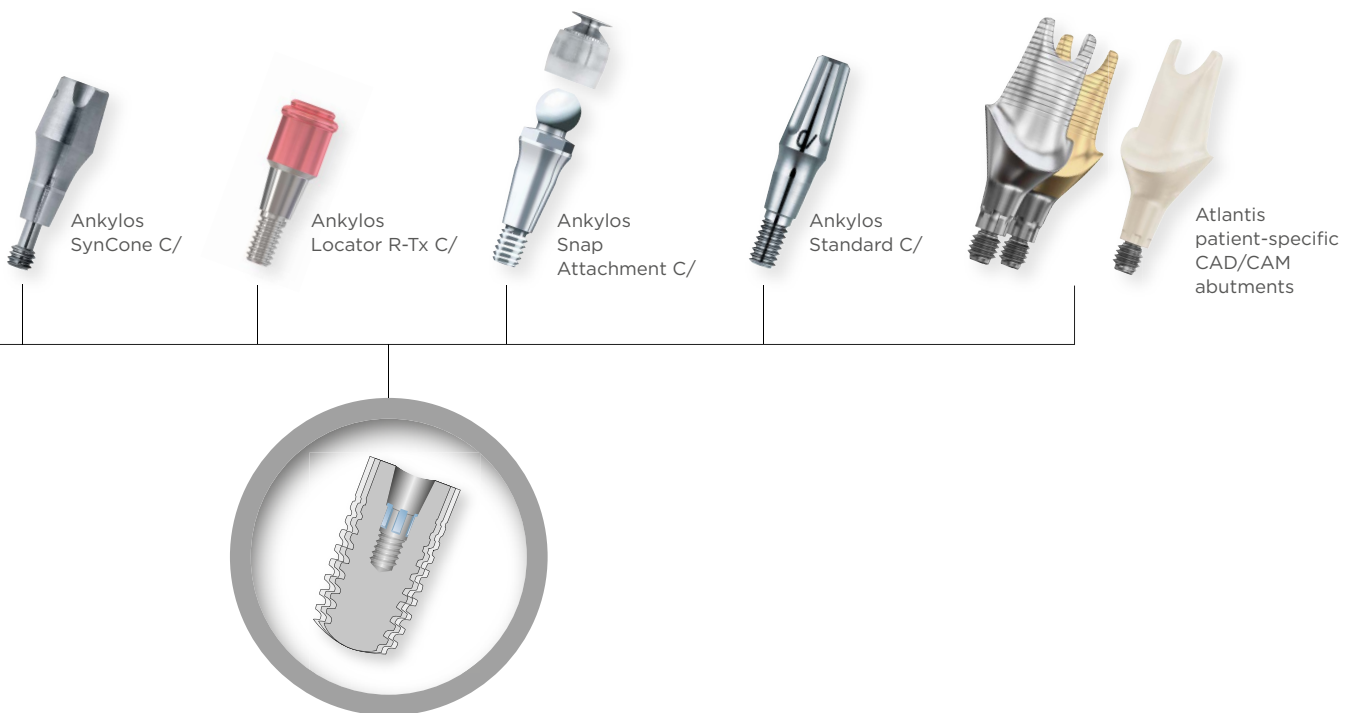

# The prosthetic principle of Ankylos<sup>®</sup>

Based on the friction-locked and keyed TissueCare connection, the Ankylos system concept also facilitates high flexibility in placing the abutments in the implant. The abutments with tapered connection geometry (C/) can be freely turned in the implant and, hence, can always be positioned at the optimal angle for the respective prosthetic restoration.

Additional indexed prosthetic components (/X) may facilitate positioning the abutments, provided that the abutment is not required to be freely rotatable.

All components marked C/X, C/ or /X will fit Ankylos C/X. Restorations using Ankylos plus implants are only possible using components with the C/ marking.

## Indexing option

Regardless of which implant is placed, abutments from the Ankylos Balance Anterior and Regular prosthetics ranges as well as the TitaniumBase, offer you the choice between indexed and non-indexed prosthetic restorations:

- Indexed components for precise, straightforward placement of the abutments in a range of six positions
- Non-indexed components for freely positionable abutments

The tapered Ankylos TissueCare connection provides both options with optimal stability and rotation locking.

The placement of the prosthetic abutments can also be simplified by using the positioning aid (index) whenever this facilitates the prosthetic procedure. If the index hampers the procedure, abutments fitted with the tapered connection alone can be used.

All Ankylos prosthetic abutments are laser-marked corresponding with your intended use:

- Components with the "C/" marking use only the taper for the connection and are not indexed.
- Components with the "/X" marking are indexed. These use the index for positioning the abutments in six possible positions.
- Components with the "C/X" marking are used for indexed or non-indexed prosthetics.

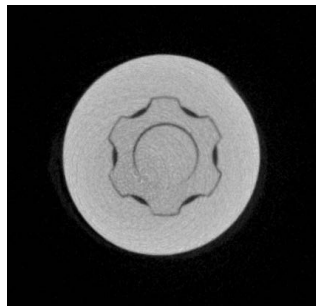
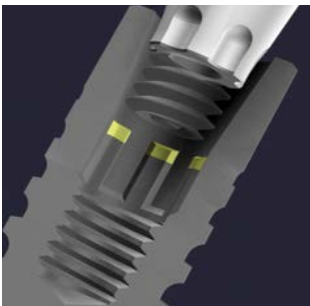

C/



/X



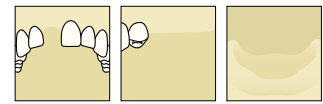



# Ankylos<sup>®</sup> prosthetics navigator

Depending on the indication and the type of prosthetic restoration intended, the Ankylos system offers different options for fabricating the suprastructure. Since all abutments are freely combinable a decision for the prosthetic strategy can still be made even after implant healing or when the abutment is uncovered.

Hence, prosthetically, the best functional and esthetic solution is realized for each individual case.

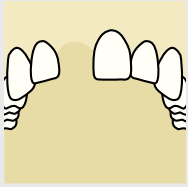
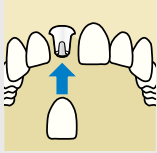
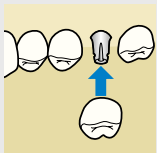
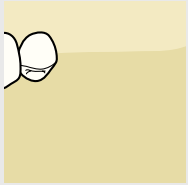
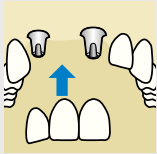
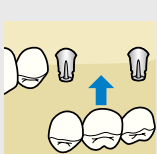
Detailed directions for selecting the most suitable prosthetic procedure for the individual case can be found on the following pages.

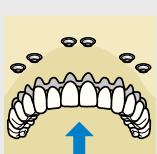
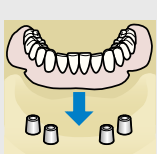
 <p>Single-tooth replacement</p>	 <p><b>Crown / anterior region:</b></p> <ul style="list-style-type: none"> <li>• Ankylos Balance Anterior C/ or /X</li> <li>• Ankylos TitaniumBase C/ or /X</li> <li>• Atlantis patient-specific abutments</li> </ul>
	 <p><b>Crown / posterior region:</b></p> <ul style="list-style-type: none"> <li>• Ankylos Regular C/ or /X</li> <li>• Ankylos Regular C/ or /X with 3-in-1 cap</li> <li>• Ankylos Standard C/</li> <li>• Ankylos TitaniumBase C/ or /X</li> <li>• Atlantis patient-specific abutments</li> </ul>
 <p>Larger tooth gaps</p>	 <p><b>Bridge / anterior region:</b></p> <ul style="list-style-type: none"> <li>• Ankylos Balance Anterior C/ or /X</li> <li>• Ankylos TitaniumBase C/ or /X</li> </ul>
	 <p><b>Bridge / posterior region:</b></p> <ul style="list-style-type: none"> <li>• Ankylos Regular C/ or /X</li> <li>• Ankylos Regular C/ or /X with 3-in-1 cap</li> <li>• Ankylos Standard C/</li> <li>• Ankylos Balance Base Abutment C/</li> <li>• Ankylos TitaniumBase C/ or /X</li> <li>• Ankylos Balance Base Abutment C/, Atlantis bridge</li> </ul>
 <p>Edentulous jaw</p>	 <p><b>Bridge (fixed):</b></p> <ul style="list-style-type: none"> <li>• Ankylos Balance Base Abutment C/, Atlantis bridge</li> <li>• Ankylos Regular C/ or /X</li> <li>• Ankylos Regular C/ or /X with 3-in-1 cap or Ankylos Standard C/</li> </ul>
	 <p><b>Overdenture (removable):</b></p> <ul style="list-style-type: none"> <li>• Ankylos Balance Base Abutment C/, Atlantis bar</li> <li>• Ankylos Balance Base Abutment C/</li> <li>• Ankylos SynCone C/</li> <li>• Ankylos Locator R-Tx C/</li> <li>• Ankylos Snap Attachment C/</li> </ul>

# Solutions for single-tooth replacement

For the replacement of single teeth with implant-supported single crowns, the Ankylos system has a wide selection of prosthetic options for fabricating naturally and esthetically pleasing restorations with durable retention of the peri-implant hard and soft tissue.

Select the most suitable solution for the individual case based on the following overview. Both, pre-fabricated abutments for conventionally fabricated prosthetics as well as patient-specifically planned and CAD/CAM-fabricated abutments for highly esthetic restorations are at your disposal.

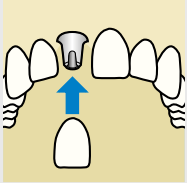
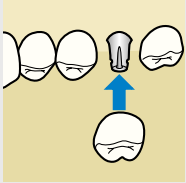
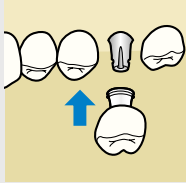
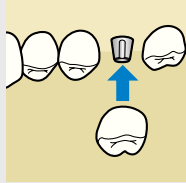
Conventionally fabricated solutions for <b>Crowns / anterior region</b>	Conventionally fabricated solutions for <b>Crowns / posterior region</b>		
			
<p><b>Esthetic:</b> <b>Ankylos Balance Anterior C/ or /X</b></p>	<p><b>Esthetic:</b> <b>Ankylos Regular C/ or /X</b></p>	<p><b>Functional:</b> <b>Ankylos Regular C/ or /X with 3-in-1 cap</b></p>	<p><b>Functional:</b> <b>Ankylos Standard C/</b></p>
<p>The design of the Ankylos Balance Anterior C/ and /X abutments is specially adapted to the anatomical and peri-implant situation in the anterior region. A wide assortment of indexed and non-indexed design variants and the patient-specific individualisation of the abutments provide optimal integration for the crowns which can be cemented or laterally screw-retained.</p>	<p>The particular strength of the Ankylos Regular C/ and /X abutments is in the posterior region. Thanks to the convex sulcus design, you can also optimally fulfill the esthetic requirements of your patients in the side tooth region. Customizable indexed and non-indexed abutments with a wide range of forms and sizes facilitate the efficient fabrication of the crowns which can be cemented or laterally screw-retained.</p>	<p>If you require a simple, economical solution, Ankylos Regular C/ and /X abutments with 3-in-1 cap are your first choice. The abutment selected at the chairside remains in the mouth during the entire treatment procedure; there is no need to change abutment components. Taking the impression on the abutment level, fabricating a temporary denture at the chairside and fabricating the cementable crown in the laboratory are all performed on the multifunctional cap, which is simply clicked onto the abutment in the patient's mouth.</p>	<p>Ankylos Standard C/ abutments are another option for straight-forward reconstruction of edentulous gaps by means of caps that can be attached to the integrated abutments. Due to the narrower design of the standard abutments, these are particularly suitable for more confined spaces. Both cementable and screw-retained crowns can be fabricated on Ankylos Standard C/ abutments.</p>
<p><b>Directions: see page 20 ff.</b></p>	<p><b>Directions: see page 28 ff.</b></p>	<p><b>Directions: see page 28 ff.</b></p>	<p><b>Directions: see page 82 ff.</b></p>

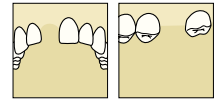

CAD/CAM prosthetics for  
**Crowns / anterior and posterior region**

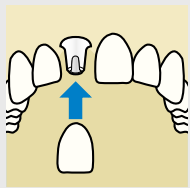

**Patient-specific and highly esthetic: Ankylos TitaniumBase C/ or /X**

The Ankylos Titanium-Base allows for the fabrication of esthetically high-quality ceramic abutments with titanium core. With these adhesive bases with prefabricated taper connection, available both, indexed and non-indexed, patient-specific restorations can be fabricated that are as close as possible to the natural esthetics of the anterior and posterior regions.

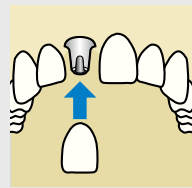

**Patient-specific and highly esthetic: Atlantis CAD/CAM abutments**

Atlantis abutments for Ankylos are the one-piece solution for fabrication of patient-specific CAD/CAM restorations. The abutments are centrally fabricated on the basis of the individual anatomical conditions. They are available indexed made from titanium, gold-shaded titanium and zirconia; available in different shades. Your dental laboratory will coordinate the process and elaborate the crown just as usual.

**Directions: see page 20 ff. corresponding to Ankylos Balance C/ or /X**

# Solutions for larger tooth gaps

Ankylos also provides a large range of options for restoration in larger edentulous gaps and free-ends – both, for conventional restorations as well as for digitally fabricated CAD/CAM prosthetics. The following is an overview of the options for providing your patients with a multi-span bridge.

As well as a bridge, in these cases, restoration is also possible using single crowns following a tooth-by-tooth concept. For this purpose, make your decision using the options shown on the previous page for single-tooth restorations.

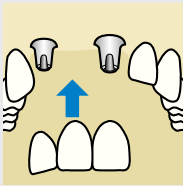
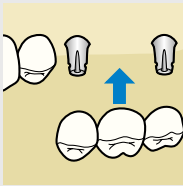
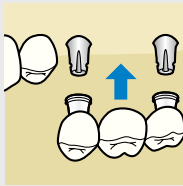
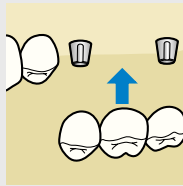
Conventionally fabricated solutions for <b>Bridges / anterior region</b>	Conventionally fabricated solutions for <b>Bridges / posterior region</b>		
			
<p><b>Esthetic:</b> <b>Ankylos Balance Anterior C/ or /X</b></p>	<p><b>Esthetic:</b> <b>Ankylos Regular C/ or /X</b></p>	<p><b>Functional:</b> <b>Ankylos Regular C/ or /X with 3-in-1 cap</b></p>	<p><b>Functional:</b> <b>Ankylos Standard C/</b></p>
<p>The design of the Ankylos Balance Anterior C/ and /X abutments is specially adapted to the anatomical and peri-implant situation in the anterior region. A wide assortment of indexed and non-indexed design variants and the option of grinding the abutments provide optimal integration for the bridges which can be cemented or laterally screw-retained.</p>	<p>The particular strength of the Ankylos Regular C/ and /X abutments is in the posterior region. Thanks to the convex sulcus design, you can also optimally fulfill the esthetic requirements of your patients in the side tooth region. Indexed and non-indexed customizable abutments with a wide range of forms and sizes facilitate the efficient fabrication of the bridges which can be cemented or laterally screw-retained.</p>	<p>If you require a simple, economical solution, Ankylos Regular C/ and /X abutments with 3-in-1 cap are your first choice. The abutment selected at the chairside remains in the mouth during the entire treatment procedure; there is no need to change abutment components. Taking the impression on the abutment level, fabricating a temporary denture at the chairside and fabricating the cementable bridge in the laboratory are all performed on the multifunctional cap, which is simply clicked onto the abutment in the patient's mouth.</p>	<p>Ankylos Standard C/ abutments are another option for straightforward reconstruction of edentulous gaps by means of caps that can be attached to the integrated abutments. Due to the narrower design of the standard abutments, these are particularly suitable for more confined spaces. Both cementable and screw-retained bridges can be fabricated on Ankylos Standard C/ abutments.</p>
<p><b>Directions: see page 20 ff.</b></p>	<p><b>Directions: see page 28 ff.</b></p>	<p><b>Directions: see page 28 ff.</b></p>	<p><b>Directions: see page 82 ff.</b></p>

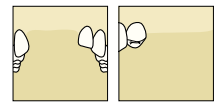

CAD/CAM prosthetics for  
**Bridges / anterior and posterior region**

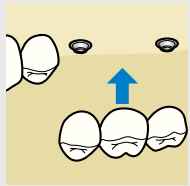

**Simple:  
Ankylos Balance  
Base Abutment C/**

If straightforward and efficient fabrication of the bridge should be a priority, a bridge restoration on Ankylos Balance Base Abutments C/ is an option. The prosthetic abutments can be selected both in the laboratory and directly at the chair-side.

As cementing is contraindicated due to the low abutment height, only screw-retained bridges can be fabricated on these abutments.

**Directions: see page 40 ff.**

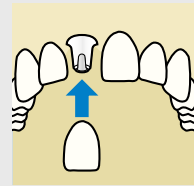

**Patient-specific and  
highly esthetic: Ankylos  
TitaniumBase C/ or /X**

The Ankylos Titanium-Base allows for the fabrication of esthetically high-quality ceramic abutments with titanium core. With these adhesive bases with prefabricated taper connection, available both, indexed and non-indexed, patient-specific restorations can be fabricated that are as close as possible to the natural esthetics of the anterior and posterior regions.

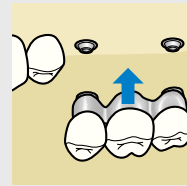

**Individual by CAD design:  
Ankylos Balance Base  
Abutment C/ with  
Atlantis bar**

With patient-specific, screw-retained Atlantis bridgework on Ankylos Balance Base Abutments C/, you can provide edentulous and partially edentulous patients with a fixed restoration of utmost precision. The bridge framework is centrally designed and fabricated with the collaboration of your dental laboratory and fits tension-free. The individually milled metal structure is veneered in your dental laboratory as usual.

**Directions: see page 40 ff.**

# Solutions for the edentulous jaw

With Ankylos, the edentulous jaw can be restored either using an implant-supported bridge (fixed) or a removable overdenture anchored to the implant.

Here, too, there are several options for both methods – from straightforward, standardized solutions right up to customized premium restorations designed using the CAD/CAM process.

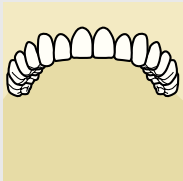

**Conventionally and CAD/CAM-fabricated solutions for Bridges (fixed)**

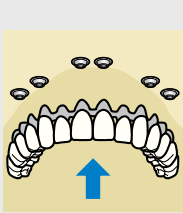

**Individual by CAD design:  
Ankylos Balance Base Abutment C/ with Atlantis bridge**

With patient-specific screw-retained Atlantis bridgework on Ankylos Balance Base Abutments C/, you can also provide edentulous and partially edentulous patients with CAD/CAM bridges on six or more implants, tension-free and with utmost precision. Dividing the spans is not necessary. In addition, the individually milled metal structure that is veneered in your dental laboratory as usual will ensure a brilliant esthetic result.

**Directions: see page 40 ff.**

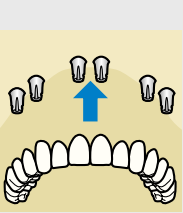

**Esthetic:  
Ankylos Regular C/ or /X**

Ankylos Regular C/ and /X abutments with convex sulcus design guarantee the optimal combination of functionality and esthetics, even for extensive multi-span bridge constructions. Customizable indexed and non-indexed abutments with a wide range of forms and sizes facilitate the efficient fabrication of the bridges, which can be cemented or laterally screw-retained.

**Directions: see page 28 ff.**

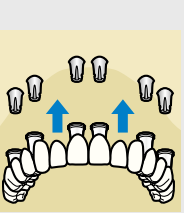

**Functional:  
Ankylos Regular C/ or /X with 3-in-1 cap or Ankylos Standard C/**

Without doubt, the preeminent choice in the prosthetics range when an economical, straightforward procedure that is gentle on the patient is required, the simplified procedure using caps that can be attached to the abutment is also suitable for extensive prosthetic work. Both Ankylos Regular C/or /X and Ankylos Standard C/ abutments with the correct caps for each situation can be used here.

**Directions:  
see page 28 ff.: (Regular) and page 82 ff. (Standard)**

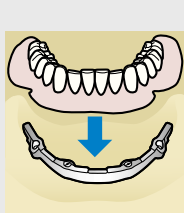

**Individual by CAD design:  
Ankylos Balance Base Abutment C/ with Atlantis bar**

With patient-specific Atlantis bar restorations on Ankylos Balance Base Abutments C/, edentulous patients can be provided with removable CAD/CAM restorations on implants, tension-free and with utmost precision. The bar is centrally fabricated with the collaboration of your dental laboratory in a customized design and is seated tension-free, even on the first insertion. The prosthesis is fabricated in the laboratory as usual.

**Directions: see page 40 ff.**



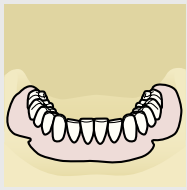

Conventionally and CAD/CAM-fabricated solutions for  
**Overdentures (removable)**

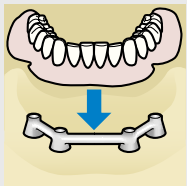

**Functional:  
Ankylos Balance Base  
Abutment C/**

A simple option for the fabrication of functional bar-supported prostheses for the maxilla and the mandible on Ankylos Balance Base Abutments C/. The prosthetic abutments can be selected in the laboratory as well as directly at the chairside. Prefabricated high gold-content precious metal alloy or titanium components facilitate the efficient fabrication of the bar prosthesis in the laboratory.

**Directions: see page 46 ff. (Balance Base Abutment) and page 82 ff. (Standard)**

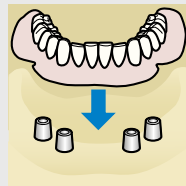

**Prefabricated  
with immediate  
restoration option:  
Ankylos SynCone C/**

Ankylos SynCone C/ abutments facilitate rapid and minimal invasive restoration of the edentulous mandible with an immediately loaded prosthesis on four prefabricated interforaminally telescopic crowns. Ankylos SynCone can also be used in the maxilla and the mandible for the purposes of delayed restoration. Intraoral bonding provides the prosthesis with a tension-free fit. The delicate denture saddle gives a high degree of wearing comfort and allows excellent hygiene.

**Directions: see page 64 ff.**

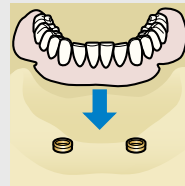

**Simply flexible:  
Ankylos Locator R-Tx C/**

With the Ankylos Locator, you secure coverdentures in the edentulous jaw fast and simple, even when space is limited. The self-aligning design supports fixation in the mouth with one click yet for patients with restricted mobility. Prosthesis retention can be defined individually and axial divergences up to 60° between two implants can be compensated.

**For full product assortment and step-by-step procedures refer to [www.zestdent.com](http://www.zestdent.com) for more information.**

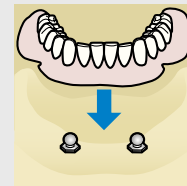

**Simple:  
Ankylos Snap  
Attachment C/**

Ankylos Snap Attachment C/ abutments allow a straightforward, inexpensive fixation for overdentures on two implants in the edentulous mandible. The restoration can be fabricated directly at the chairside or the prosthesis can be fabricated in the laboratory.

**Directions: see page 78 ff.**

# Basic guidelines for soft tissue management with Ankylos<sup>®</sup>

Free from micro-movement and conceived for bacteria tightness, the Ankylos TissueCare connection ensures stable tissues on the long term.

The advantages of this specific connection geometry however only become effective, if the procedure of soft tissue contouring complies with the following guidelines.

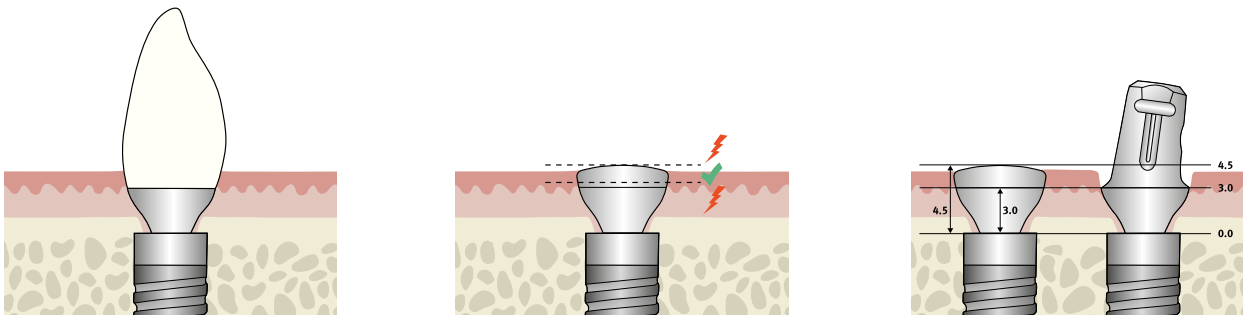

## Transition implant-abutment displaced toward the center

Some special characteristics have to be considered for soft tissue contouring and the choice of the final abutment:

- Due to the taper connection, the diameter of the Ankylos abutments on the implant level is markedly smaller than the diameter of the implant itself.
- Soft tissues are also located under the flanks of the abutment.

## Selection of the correct gingiva height

- The illustration shows the correct usage of a gingiva former.
- If the gingival level lies in the area between the two dotted lines, the correct gingiva former has been selected.
- If the level is above the upper dotted line, a higher gingiva former should be selected; if it is below the lower dotted line, a lower one should be selected.

## Selection of the gingiva former corresponding to the abutment

- The gingiva former and final abutment should be selected so that they correspond in prosthetic range and gingival height.
- The description of the height of the gingiva former as shown above (GH 3.0) only refers to the region from the interface level to the edge of the crown.
- The entire gingiva former is always approximately 1.5 mm higher than the nominal height, viewed from the interface level (here: overall height 4.5 mm), in order also to shape the first part of the crown profile.

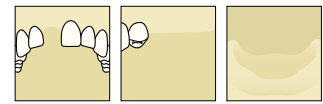

Gingiva former and final abutment should be selected in correspondence of prosthetic range and gingiva height. Therefore, please make sure to use the components indicated for the respective prosthetic range in the following chapters.

Gingiva formers must be sterilized before use.

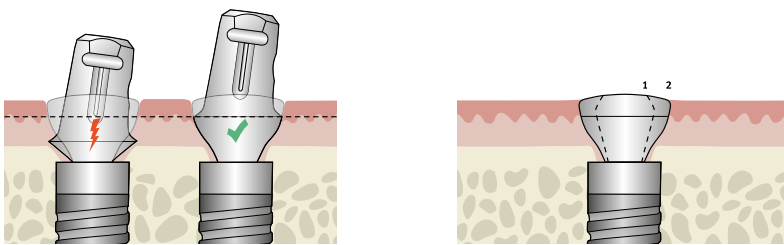

If the soft tissue passage formed is smaller than the profile of the abutment used, this may result in an avoidable compression of the gingiva.

This effect occurs when:

1. The gingiva former is markedly higher than the gingival level and the abutment used later on.
2. The gingiva former is suitable to the gingival height, but the gingival height of the final abutment is lower than that of the gingiva former used (see illustration).
3. The final abutment has a larger diameter than the gingiva former used (e.g. in case of a different prosthetic range).

### Gradual widening of the gingiva

- In case of stiff mucosa, the tissues must be gradually widened to the desired diameter.
- Here, commence first with a small sulcus former. Switch to a larger diameter after 5-7 days.
- The shape of the soft tissue passage should at least correspond to the abutment geometry, in case of doubt, it should rather be selected larger.
- Due to the counter force exerted by the gingiva, an undersized contouring might lead to problems when placing the abutments. Over-compression of the gingiva may result in recession of the soft tissue.

### Naturally beautiful teeth, even after many years



Irritation-free, healthy soft tissues prior to incorporating the final restoration.



Natural soft tissue contour thanks to the TissueCare connection (courtesy of Dr. Eduard Eisenmann, Berlin/D).

Advantages of the Ankylos system supporting esthetics:

1. Provides adequate space for healthy, protective soft tissues
2. Protects areas of thin soft tissue
3. Prevents the abutment from possible shimmering through the tissues
4. Ensures optimal esthetic results

# Balance C/ or /X

Ankylos Balance Anterior C/ and /X abutments are outstandingly suitable for your patients' restorations using single crowns and bridges optimally adjusted to periimplant conditions.

The prosthetic abutments of the Balance range are available as freely positionable with tapered connection geometry (C/), Ankylos Balance Anterior abutments also with additional index serving as positioning aid (/X).

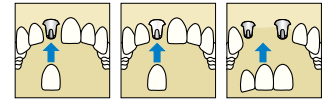

# Crowns and bridges on Ankylos® Balance Anterior C/ or /X

## Ankylos® Balance Anterior C/ or /X

- For esthetically demanding crowns and bridges in the anterior region
- Cemented or screw-retained
- Anatomical, customizable abutments made from titanium alloy Ti6Al4V
- With indexing or freely positionable

All prefabricated Ankylos Balance prosthetic abutments are selected and customized in the dental laboratory.

## CAD/CAM prosthetic solutions

As an individual alternative to the prefabricated Ankylos Balance C/ and /X abutments, two solutions for patient-specific CAD/CAM-fabricated abutments are available:

- Ankylos TitaniumBase for the fabrication of esthetically high-quality ceramic abutments with prefabricated titanium core
- Atlantis abutments made of titanium, gold-shaded titanium or zirconia, the patient-specific one-piece solution for crowns.\*

With the flexibility of patient-specific abutments, your restorations persuade with even more esthetics and functionality.

\* Available at: [www.atlantisweborder.com](http://www.atlantisweborder.com)



1-5 | Replacement of an upper incisor with Ankylos Balance Anterior C/ (Photos: Dentsply Sirona Implants).

# Prosthetic components Ankylos® Balance C/ or /X

All prosthetic Ankylos C/X components are laser-marked to indicate their use:

- Components with the “C/” mark use only the “C” one for the connection and are not indexed. This means that the abutment components can be positioned as desired and are completely locked by the taper to prevent rotation.

- Components with the “/X” mark are indexed. The index is used to position the abutment components in one of six possible positions. In this case also, the taper guarantees optimum stability and rotation locking.

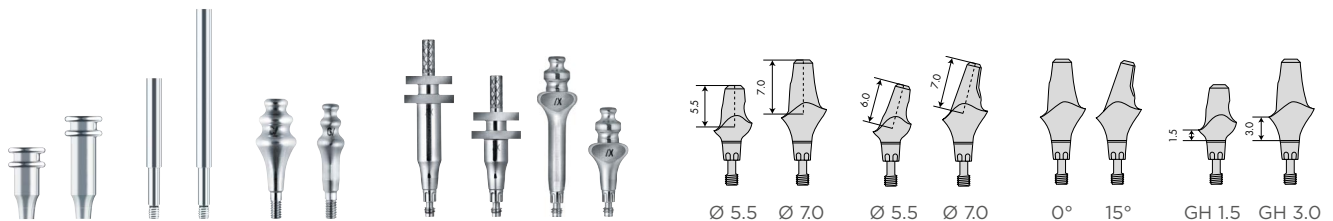

Ankylos Balance C/ transfer post with screw (left) and Ankylos Balance C/ repositioning post (right)

Ankylos /X transfer posts PickUp and repositioning technique

Dimensions of the Ankylos Balance Anterior C/ and /X abutment [mm]

## Impressions Ankylos Balance C/

### Ankylos Balance C/ Transfer Post

- For transferring the implant position to the master cast using the PickUp technique (open tray)
- Available in two lengths
- Two-piece with separate screw

### Ankylos Balance C/ Repositioning Post

- For transferring the implant position to the master cast using the repositioning technique (closed tray)
- Repositioning post narrow for cases with limited space available
- One-piece with integrated thread

## Impressions Ankylos Balance /X

### Ankylos /X Transfer Post (PickUp Technique)

- For transferring the implant position to the master cast using the PickUp technique (open tray)
- Available in two lengths
- One-piece with integrated straining screw, screw extension enclosed

### Ankylos /X Transfer Post (Repositioning Technique)

- For transferring the implant position to the master cast using the repositioning technique (closed tray)
- Available in two lengths
- One-piece with integrated straining screw

## Model fabrication Balance C/

### Ankylos Balance C/ Implant Analog

- For fixing the prosthetic components in the master cast
- Surgical steel, DIN 1.4305

## Model fabrication Balance /X

### Ankylos C/X Implant Analog

- For fixing the prosthetic components in the master cast
- Surgical steel, DIN 1.4305



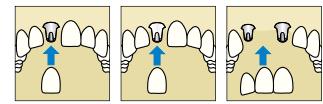

## Instruments

### Ankylos Laboratory Screwdriver 1.0 mm Hexagon

- Reduced torque 10 Ncm
- Prevents stripping the straining screw



### Ankylos Handle for Implant Analogs and Abutments

- For improved management of prosthetic components during laboratory machining
- Prevents damage to the cast



Ankylos Balance Anterior C/ abutment made of titanium alloy

Indexed Ankylos Balance Anterior /X abutment made of titanium alloy

## Prosthetic restoration

### Ankylos Balance Anterior C/ or /X Abutment

- For esthetically demanding crowns and bridges in the anterior region
- With indexing (/X) or freely positionable (C/)
- one-piece with integrated straining screw
- Easily adaptable to the clinical situation with two diameters (large and small), two gingival heights (1.5 and 3.0 mm) and two angulations (0° and 15°)
- Can be customized by grinding
- Cementable or laterally screw-retained with M 1.4 fixation screw lateral hexagon (red, order no. 3105 6301)
- Cannot be cast, cannot be fired
- Titanium alloy Ti6Al4V, ISO 5832-3

### Ankylos M 1.4 Lateral Hex Fixation Screw

- For fabricating laterally screw-retained crowns and bridges on Ankylos Regular C/ and /X abutments
- Order no. 3105 6301 (red)
- Permador cast-to horizontal screw seat available (order no. 3105 6304)



# Step-by-step: Preparing the cast and selection of the abutments

In as far as prosthetic restoration is planned on Ankylos Balance Anterior C/ abutments, the impression is performed on the patient with Ankylos Balance C/ transfer posts PickUp (open tray) or reposition. The Ankylos Balance C/ implant analogs are fixated in these.

Only Ankylos /X transfer abutments are used for restorations on Ankylos Balance Anterior /X abutments, as only these can transfer the index position. In this case the indexed Ankylos C/X implant analogs are used.

## Ankylos Balance Anterior C/

## Ankylos Balance Anterior /X

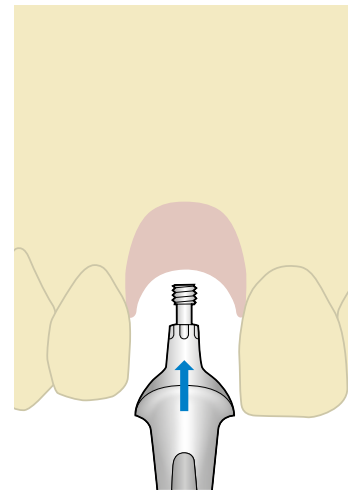
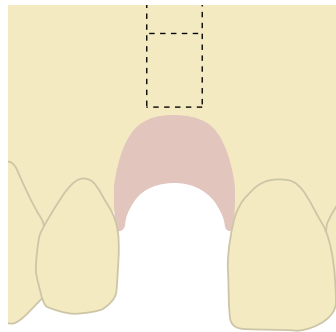
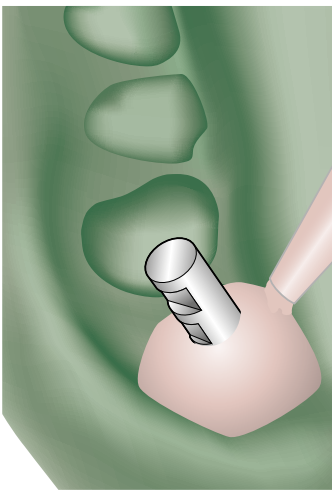

### Fixing the implant analog and preparing mucosa mask

Screw the implant analogs to the transfer posts fixed in the impression. Use Ankylos Balance C/ analog implants if non-indexed transfer abutments were used. The Ankylos C/X analog implant is used for indexed transfer abutments. The fit of the corresponding analog implant to the transfer abutment in the connection taper and, if given, the index, must be ensured. Insulate the impression with silicone lubricant prior to casting and coat the area surrounding the implant analog with gingiva casting material. Observe the manufacturer's directions.

### Casting the model

Prepare the master cast using dental stone class IV. Here, ensure adequate height such that the implant analog is covered with plaster. Then, loosen the transfer screw and remove the impression.

If the gingiva former is smaller than the abutment to be selected, the mucosa mask can affect the fit. In this case, adjust the mucosa mask after selecting the abutment and advise the practitioner.

### Selection of prosthetic abutment

Select suitable Ankylos Balance Anterior C/ or /X abutment respectively.

For selecting the abutments, Balance C/ temporary abutments may be used as try-in abutments and will provide important information in terms of angulation and height.



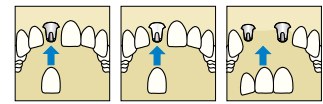

Do not damage the straining screw during grinding. Ensure an adequate wall thickness also, and an adequate abutment height for cemented suprastructures. Do not grind the lateral thread hole, particularly in screw-retained suprastructures. To avoid stripping the straining screw, use the blue laboratory screwdriver with torque (10 Ncm). Enlarge the access channel for the screwdriver as the hexagonal torque insert applied in the patient's mouth is slightly wider.

### Ankylos Balance Anterior C/

### Ankylos Balance Anterior C/

### Ankylos Balance Anterior /X

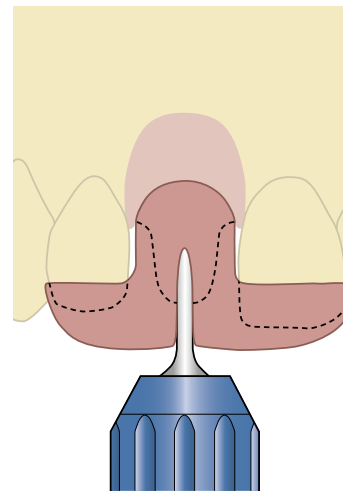
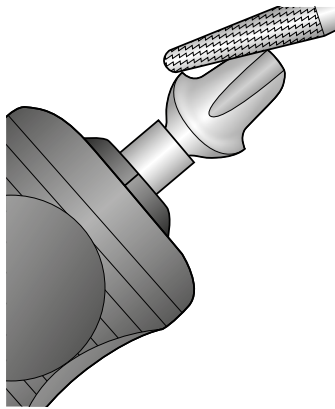
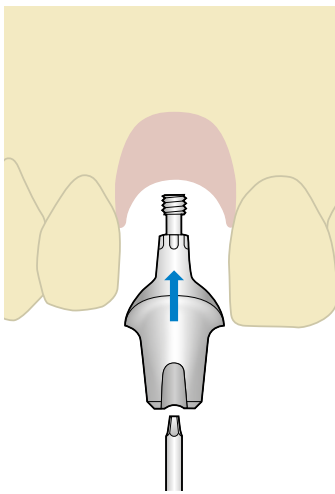

### Customizing the Ankylos Balance Anterior C/ and /X abutment

### Transfer key for Ankylos Balance Anterior C/

Remove mucosa mask. Fix the Ankylos Balance Anterior /X abutment in the desired position in the index. When using the freely positionable Balance Anterior C/ abutments, align these through free rotation in 360°. Screw abutments into the model using the laboratory screwdriver 1.0 mm hex with 10 Ncm torque and align to desired position.

Grind the Ankylos Balance Anterior C/ or /X abutment to adjust it to the individual situation. The prefabricated taper surfaces must not be processed. Grinding the abutment in the Ankylos handle for implant analogs and abutments makes them easier to handle and prevents damage to the master cast.

Prepare a transfer key to retrieve the selected position on the cast and later on in the mouth using the customized Ankylos Balance Anterior C/ abutment.

Ensure a consistent insertion direction for bridge constructions when grinding the abutments.

For bridge constructions, connect the bridge sections with a prefabricated plastic or metal bar in order to reduce shrinkage due to polymerization. For larger reconstructions, the transfer key should be in sections.

The transfer key is handed over to the dental practice together with the completed prosthetic restoration.

# Step-by-step: Crowns and bridges with Ankylos<sup>®</sup> Balance Anterior C/ or /X

Both cemented and laterally screw-retained suprastructures can be prepared on Ankylos Balance Anterior C/ and /X abutments.

## Ankylos Balance Anterior C/

## Ankylos Balance Anterior /X

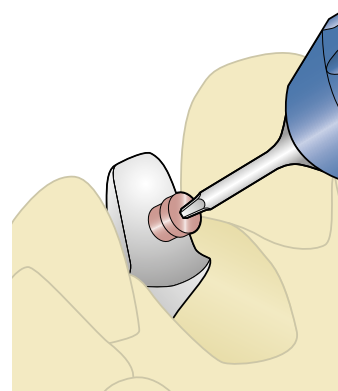
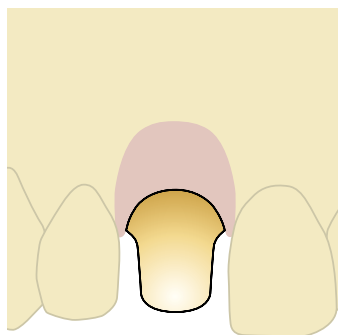
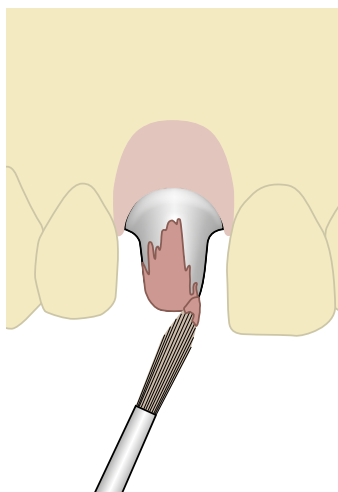

### Cemented suprastructure on Ankylos Balance Anterior C/ or /X

For cemented suprastructures, block the screw channel and the lateral hole of the Ankylos Balance Anterior C/ or /X abutments and wax up the crown as usual.

The framework and veneering correspond with the current dental procedures for metal-ceramic or all-ceramic suprastructures. Cleanable interdental spaces are desirable in bridge constructions. Please observe the manufacturers' processing directions.

### Screw-retained suprastructure on Ankylos Balance Anterior C/ or /X

The suprastructure can also be laterally screw-retained, if preferred. For this, attach the red M 1.4 lateral hex fixation screw (order no. 3105 6301) prior to wax-up using the laboratory screwdriver.

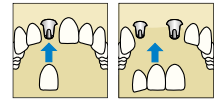

## Patient-specific Atlantis abutments

Along with the use of prefabricated Ankylos Balance Anterior C/ and /X abutments, patient-specific Atlantis CAD/CAM abutments are available.

Using the patented Atlantis VAD software, abutments are uniquely designed from the final tooth shape for a more natural esthetic result. The unique process offers unlimited possibilities and patient-specific solutions for single, multiple and full arch units.

Optimized 3D scanning of the models generates an exact virtual image. This allows each Atlantis abutment to be individually designed and produced for its specific space and in relation to the surrounding teeth.

After defining your design parameters in Atlantis WebOrder, the final design is checked for fit and occlusal clearance in a virtual environment. Before manufacturing, you can view, ask for modifications and/or approve the final design. Then, the abutments are manufactured, using state-of-the-art precision milling processes to ensure the highest precision and quality.

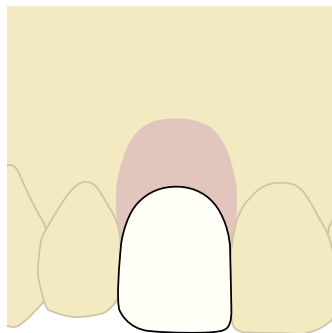
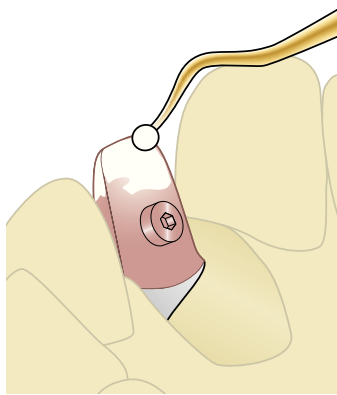

When waxing up with the cast-to-horizontal screw seat for the M 1.4 fixation screw (order no. 3105 6304), observe the processing directions for the cast-on of dental alloys.

The framework and veneering correspond with the current dental procedures for metal-ceramic or all-ceramic suprastructures. Cleanable interdental spaces are desirable in bridge constructions. Please observe the manufacturers' processing directions.

Ensure that no ceramic particles find their way into the screw channel of the abutment when applying and grinding the ceramic.

The transfer key should be handed over to the practitioner with the completed crown.

# Regular C/ or /X

The Ankylos Regular C/ or /X prosthetic range enables the fabrication of functionally and esthetically appealing reconstructions for edentulous gaps and free ends with single crowns or an implant-supported bridge. With their convex sulcus design, Ankylos Regular C/ or /X abutments have been optimized for the posterior region.

Choose between two options: the tapered TissueCare connection, with freely positionable components, or components with the tapered TissueCare connection and additional indexing as an aid to positioning.

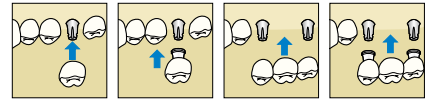

# Crowns and bridges on Ankylos® Regular C/ or /X

## Classic Ankylos® Regular C/ or /X procedure

- For esthetically demanding results
- Transfer the implant position for the laboratory with the transfer post
- Selection of the prosthetic abutment made from titanium alloy Ti6Al4V in the dental laboratory
- The suprastructure is fabricated on the original abutments
- Can be customized
- Cemented or screw-retained suprastructures

## Simplified procedure using Ankylos® Regular C/X 3-in-1 cap

- Not changing abutment components means simplified handling and optimal patient comfort
- Less irritation of the soft tissues
- Selection of the prosthetic abutment at the chairside
- The impression of the abutment position for the laboratory is taken via the 3-in-1 cap
- The suprastructure is fabricated on the 3-in-1 cap
- Cannot be customized
- Cemented suprastructures only
- Provisional restoration at the chairside is also simplified for the patient via the 3-in-1 cap

## CAD/CAM prosthetic solutions

As an individual alternative to the prefabricated Ankylos Regular C/ and /X abutments, two solutions for patient-specific CAD/CAM-fabricated abutments are available:

- Ankylos TitaniumBase for the fabrication of esthetically high-quality ceramic abutments with prefabricated titanium core
- Atlantis abutments made of titanium, gold-shaded titanium or zirconia, the patient-specific one-piece solution for crowns.\*

With the flexibility of patient-specific abutments, your restorations persuade with even more esthetics and functionality.

\* Available at: [www.atlantisweborder.com](http://www.atlantisweborder.com)

# Prosthetic components Ankylos<sup>®</sup> Regular C/ or /X

All prosthetic Ankylos C/X components are laser-marked to indicate their use:

- Components with the “C/” mark use only the “C” one for the connection and are not indexed. This means that the abutment components can be positioned as desired and are completely locked by the taper to prevent rotation.
- Components with the “/X” mark are indexed. The index is used to position the abutment components in one of six possible positions. In this case also, the taper guarantees optimum stability and rotation locking.
- Components with the C/X mark are used for indexed or non-indexed prosthetics.



Ankylos /X transfer post  
(PickUp technique),  
long and short

Ankylos /X transfer post  
(repositioning technique),  
long and short

Regardless of whether a prosthetic restoration on indexed Ankylos Regular /X abutments or on the freely positionable Ankylos Regular C/ abutments is planned, the identical components with the C/X marking are used for contouring the soft tissues and for the impression.

## Impressions

### Ankylos /X Transfer Post (PickUp Technique)

- For transferring the implant position to the master cast using the PickUp technique (open tray)
- Available in two lengths
- One-piece with integrated straining screw, screw extension enclosed

### Ankylos /X Transfer Post (Repositioning Technique)

- For transferring the implant position to the master cast using the repositioning technique (closed tray)
- Available in two lengths
- One-piece with integrated straining screw

## Model fabrication

### Ankylos Regular C/X Implant Analog

- For fixing the prosthetic components in the master cast
- Surgical steel, DIN 1.4305



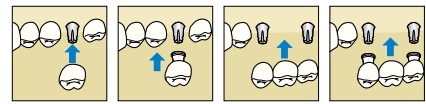

### Patient-specific Atlantis abutments

As an alternative to the prefabricated Ankylos Regular C/ or /X abutments, patient-specific Atlantis abutments can be used. For more information see page 37.



Angulations and head heights

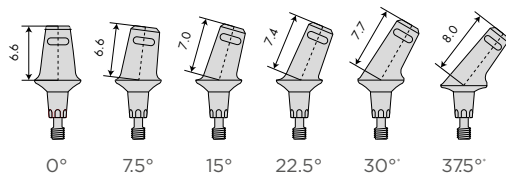

Gingival heights and diameters

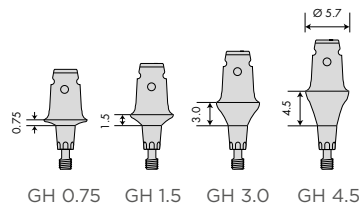

Ankylos Regular C/ or /X abutment dimensions [mm]

Ankylos Regular C/ abutments straight (above) and angled (below). Also available indexed as Regular /X.

## Prosthetic restoration

### Ankylos Regular /X or Regular C/ Abutment

- With indexing (/X) or freely positionable (C/)
- One-piece with integrated straining screw
- Easily adaptable to the clinical situation with four gingival heights (0.75/1.5/3.0/4.5 mm) and up to six angulations (0°/7.5°/15°/22.5°/30°/37.5°)\*
- Can be customized by grinding
- Cementable or laterally screw-retained with Ankylos M 1.4 lateral hex fixation screw (red, order no. 3105 6301), 30° and 37.5° angulations also with occlusal screw-retention
- Cannot be cast, cannot be fired

### Ankylos M 1.4 Lateral Hex Fixation Screw

- For fabricating laterally screw-retained crowns and bridges on Ankylos Regular C/ and /X abutments
- Order no. 3105 6301 (red)
- Permador cast-to horizontal screw seat available (order no. 3105 6304)



### Ankylos Occlusal Retaining Screw, short

- For occlusal screw retention of crowns on Ankylos Regular C/ and /X abutments with 30° and 37.5° angulations
- Order no. 3105 6022 (blue)



\* GH 0.75 up to 37.5°, GH 1.5 up to 30°

# Prosthetic components for Ankylos® Regular C/ or /X

## Simplified procedure on abutment level

The Ankylos Regular C/X 3-in-1 cap is a quick and easy option for fabricating a prosthetic restoration using unground Ankylos Regular C/ or /X abutments on the abutment level.



Ankylos Regular C/X 3-in-1 caps



Ankylos Regular C/X abutment analogs



Ankylos laboratory hex screwdriver 1.0 mm (left), Ankylos handle for abutment analogs and abutments (right)

## Ankylos Regular C/X 3-in-1 Cap

### Impressions

- For transferring the position of the prosthetic abutment to the master cast when taking the impression over Ankylos Regular C/ or /X abutments already located in the implant

### Temporary restorations

- For fabricating a temporary restoration chairside with snap effect (on unground abutments only)

### In the laboratory

- As a wax-up coping on implant analogs and unground abutments

## Ankylos Regular C/X Abutment Analog

- For attaching the prosthetics components after taking impressions via the 3-in-1 cap

## Instruments

### Ankylos Laboratory Hex Screwdriver 1.0 mm

- Reduced torque: 10 Ncm
- Prevents stripping the straining screw

### Ankylos Handle for Abutment Analog and Abutments

- For improved management of the prosthetics components during laboratory processing
- Prevent damage to the cast



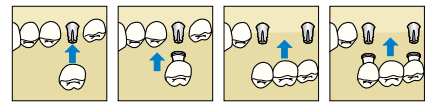

## Step-by-step: Preparing the cast

Regardless of whether you are planning a prosthetic restoration on indexed Ankylos Regular /X abutments or on the freely positionable Ankylos Regular C/ abutments, the impression is taken with identical transfer posts PickUp (open tray) or repositioning technique with the C/X mark.

They are fixed in the Ankylos Regular C/X implant analog. As an alternative the impression can be made with Ankylos C/ transfer posts. In this case a suprastructure can only be fabricated with freely positionable Ankylos Regular C/ abutments, because no index position has been transferred.

### Ankylos Regular C/

### Ankylos Regular /X

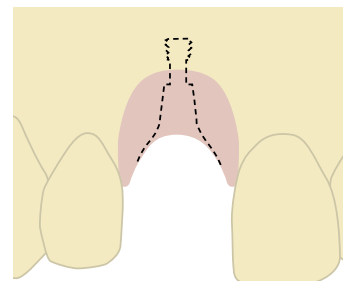
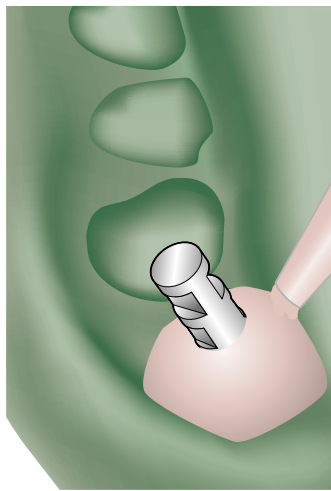
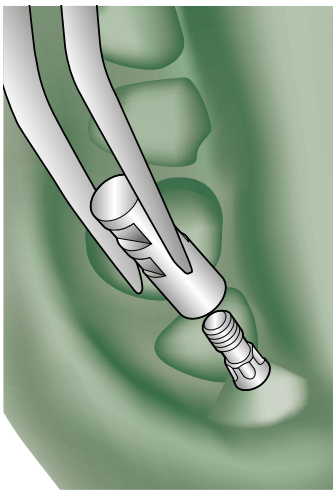

#### Fixing the Ankylos Regular C/X implant analog

Mount and screw into position the Ankylos C/X implant analog with the Ankylos transfer post fixed in the impression. The implant analog must be correctly fitted to the transfer post in the connection taper and index.

#### Mucosa mask

Insulate the impression with silicone lubricant prior to casting and coat the area around the Ankylos C/X implant analog with gingiva casting material. Observe the manufacturer's directions.

#### Casting the model

Prepare the master cast using dental stone class IV. Here, ensure adequate height such that the implant analog is covered with plaster. Then, loosen the transfer screw and remove the impression.

**Note:** The C/ implant analog can only be used with Regular C/ abutments.

# Step-by-step: Crowns and bridges, cemented or laterally screw-retained

Depending on the proposed protocol indexed Ankylos Regular /X abutments or freely positionable Regular C/ abutments are selected according to the required gingival margin and angulation.

## Ankylos Regular C/

### Ankylos Regular /X

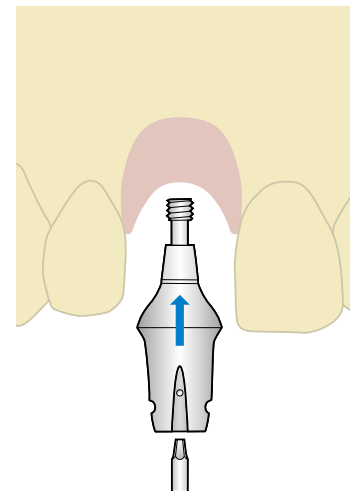
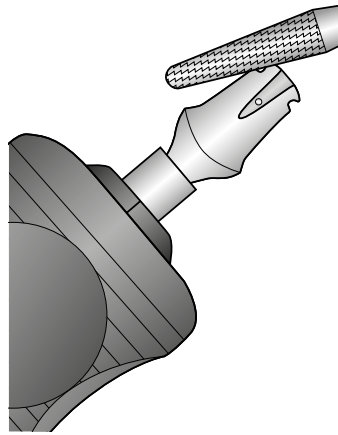
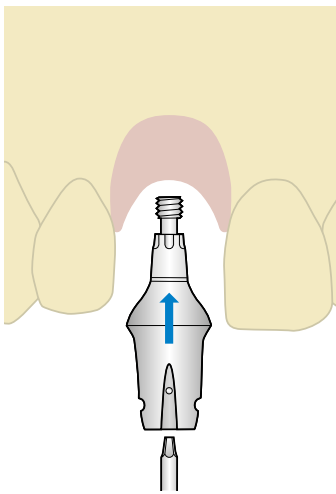

### Placing the Ankylos Regular /X abutments

Fix the Ankylos Regular /X abutment in the desired position and screw it to the master cast with the Ankylos laboratory screwdriver with torque control. With a lateral retention screw align the lateral thread in a favorable insertion direction in the index.

If the position of the Regular /X abutment is unfavorable because of the index, a non-indexed Regular C/ abutment can be used in consultation with the dentist.

### Customizing the Ankylos Regular /X abutments

Grind the Regular /X abutment to adjust it to the individual situation. The prefabricated taper surfaces and the index must not be processed. Grinding the Ankylos Regular /X abutment in the Ankylos handle for abutment analogs and abutments makes them easier to handle and prevents damage to the master cast. Therefore, make sure to have placed a Regular C/X implant analog.

### 360°-accurate alignment of Ankylos Regular C/ Abutment

Align the Ankylos Regular C/ abutment by rotating it through 360° and fix it in the desired position on the master cast with the Ankylos laboratory screwdriver with torque control. With a lateral fixation screw align the lateral thread in a favorable insertion direction in the taper.

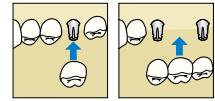

Do not damage the straining screw when grinding. Make sure that an adequate wall thickness of minimum 0.5 mm is retained, and make sure that the abutment height is adequate for cemented suprastructures. Do not grind the lateral threaded hole any thinner particularly with screw-retained suprastructures.

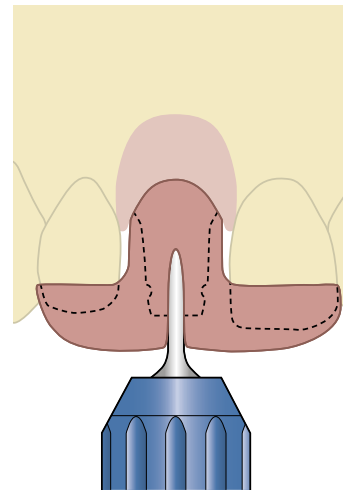
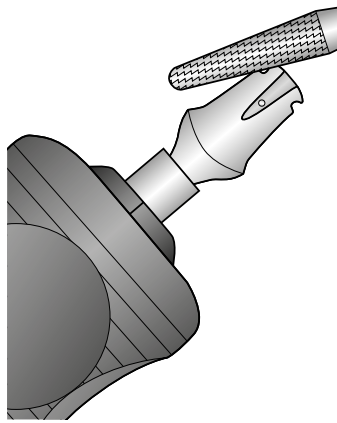
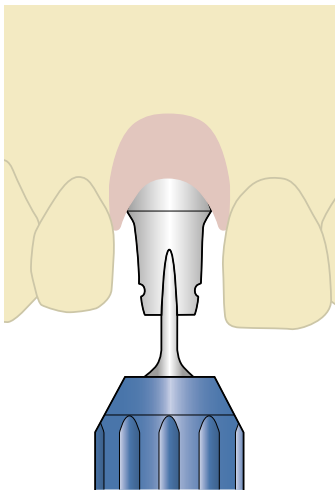

### Customizing the Ankylos Regular C/ abutments

Grind the Regular C/ abutment to adjust it to the individual situation. The prefabricated taper surfaces and the index must not be processed. Grinding the Ankylos Regular C/ abutment in the Ankylos handle for abutment analogs and abutments makes them easier to handle and prevents damage to the master cast. Therefore, make sure to have placed a Regular C/X implant analog.

### Transfer key

Prepare a transfer key to retrieve the selected position on the cast and later on in the mouth over the customized Ankylos Regular C/ abutments (block out horizontal grooves).

The transfer key is handed over to the dental practice together with the completed prosthetic restoration.

# Step-by-step: Crowns and bridges, cemented or laterally screw-retained

Crowns and bridges are fabricated on Ankylos Regular /X or Regular C/ abutments using the same procedure. Suprastructures can be cemented-in and laterally screw-retained.

## Ankylos Regular C/

## Ankylos Regular /X

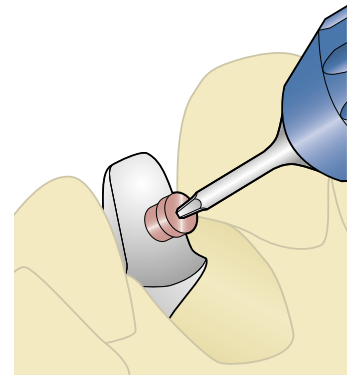
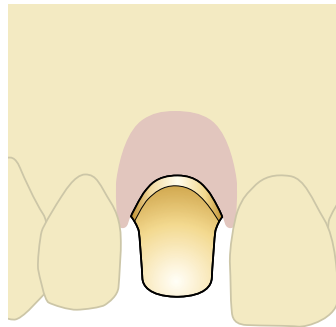
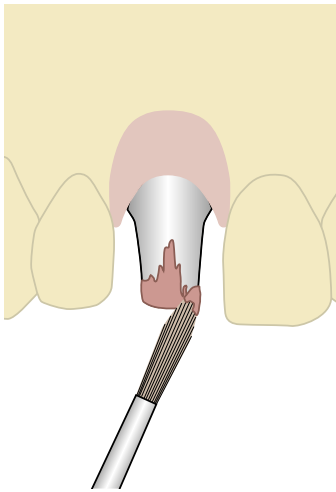

### Ankylos Regular /X and C/ Abutment - cemented

For cemented suprastructures block out the screw channel, the lateral hole and the side horizontal grooves for the transfer cap on the Ankylos Regular /X and C/ abutments and wax up the crown as usual.

In case the abutment head has not been customized, the Ankylos Regular C/X 3-in-1 cap can be used as aid for the wax-up (see page 39).

The framework and veneering correspond with the current dental procedures for metal-ceramic or all-ceramic suprastructures. Please observe the manufacturer's processing directions.

### Ankylos Regular /X and C/ Abutment - screw-retained

The suprastructure can also be laterally screw-retained, if preferred. For this, attach the red M 1.4 lateral hex fixation screw (order no. 3105 6301) prior to wax-up using the laboratory screwdriver.

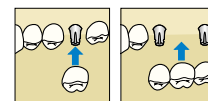

For crowns on Ankylos Regular C/abutments the transfer key must be given to the dentist with the finished crown.



### Patient-specific Atlantis abutments

Along with the use of pre-fabricated Ankylos Regular C/ or /X abutments, patient-specific Atlantis CAD/CAM abutments are available.

Using the patented Atlantis VAD software, abutments are uniquely designed from the final tooth shape for a more natural esthetic result. The unique process offers unlimited possibilities and patient-specific solutions for single, multiple and full arch units.

Optimized 3D scanning of the models generates an exact virtual image. This allows each Atlantis abutment to be individually designed and produced for its specific space and in relation to the surrounding teeth.

After defining your design parameters in Atlantis WebOrder, the final design is checked for fit and occlusal clearance in a virtual environment. Before manufacturing, you can view, ask for modifications and/or approve the final design. Then, the abutments are manufactured, using state-of-the-art precision milling processes to ensure the highest precision and quality.

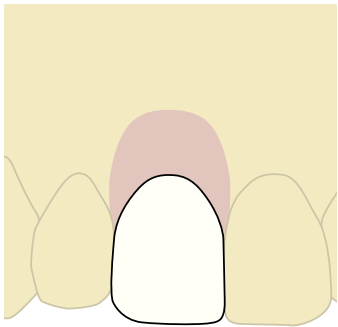
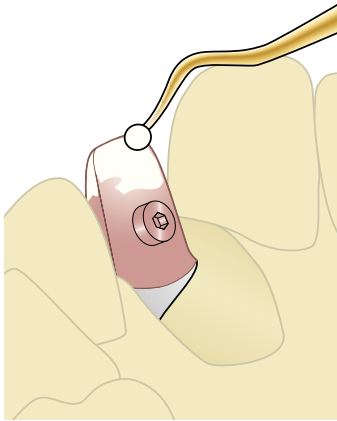

When waxing with the cast-to horizontal screw seat for M 1.4 fixation screw (order no. 3105 6304) observe the processing directions for casting dental alloys.

The framework and veneering correspond with the current dental procedures for metal-ceramic or all-ceramic suprastructures. Please observe the manufacturer's processing directions.

When applying and grinding the ceramic, prevent ceramic particles from entering the screw channel of the abutment.

## Step-by-step: Simplified procedure on the abutment level

In contrast to the procedure described above, where the prosthetic abutments are selected by the dental laboratory in cooperation with the practitioner, the selection and incorporation of the abutments prior to taking the impression takes place directly at the chairside.

The impression is taken using Ankylos Regular C/X 3-in-1 caps, which remain in the impression. Ankylos Regular C/X abutment analogs are fixed in the caps.

### Ankylos Regular C/

### Ankylos Regular /X

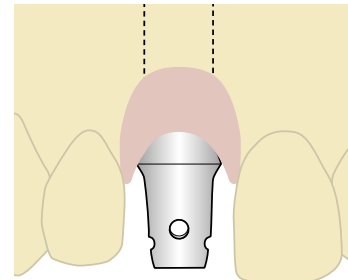
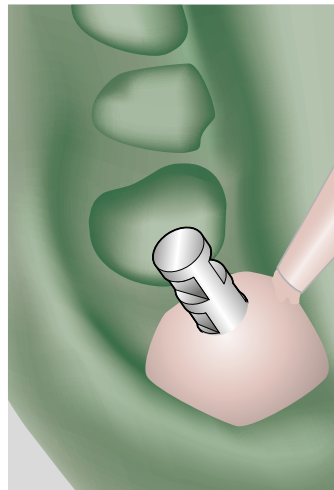
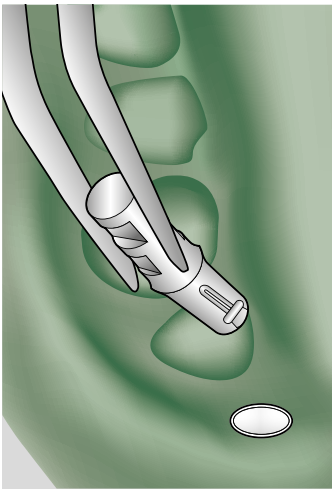

### Fixing the Ankylos Regular C/X abutment analog

Select the Ankylos Regular C/X abutment analog according to the abutment design or the angulation of the original abutment, position this in the Ankylos Regular C/X 3-in-1 cap and check for a firm fit. The geometry, angle and lateral thread of the Ankylos Regular C/X abutment analog correspond with the original abutment in the patient's mouth.

### Mucosa mask

Insulate the impression prior to casting using a silicone lubricant and coat the area around the Ankylos Regular C/X abutment analog with gingiva colored casting material. In doing so, observe the manufacturer's directions.

### Casting the model

Prepare the master cast using dental stone class IV. Here, ensure an adequate height such that the implant analog is covered with plaster.

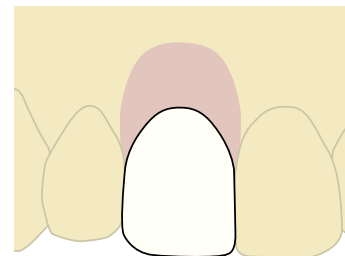
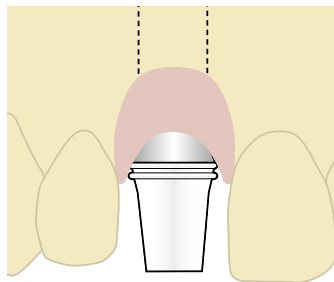
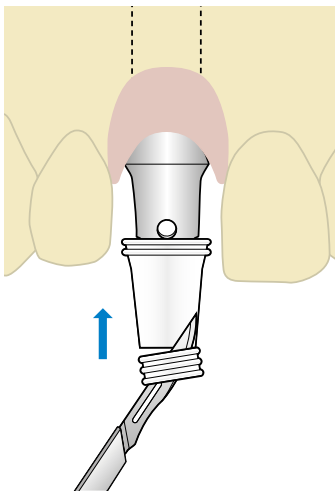
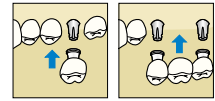

### Wax-up with the Ankylos Regular C/X 3-in-1 cap

The Ankylos Regular C/X 3-in-1 cap can also be used as a wax-up coping. Select the cap according to the abutment design or the angulation of the original abutment, then smooth off the lateral horizontal grooves for the transfer and place the cap on the abutment. Remove the retention ring on the tapered section and roughen the cap prior to casting with wax or synthetic material.

Smooth off the lateral horizontal grooves.

### Cemented suprastructure on Ankylos Regular /X and C/ abutment

For cemented suprastructures, wax up crown or bridge on the cap as usual. The framework and veneering correspond with the current dental procedures for metal-ceramic or all-ceramic suprastructures. Please observe the manufacturer's directions. The cap can be fired out without leaving a residue.

# Balance Base Abutment C/

With the Ankylos Balance Base Abutment C/ you will be able to provide your edentulous and partially edentulous patients with screw-retained bridges and removable overdentures on bars.

The suprastructure is manufactured conventionally in the dental laboratory or by means of the CAD/CAM milling process.

Rotationally symmetrical Ankylos Balance Base Abutments made of titanium alloy Ti6AlV are available with tapered connection geometry. Due to the rotational symmetry, indexing is not required.



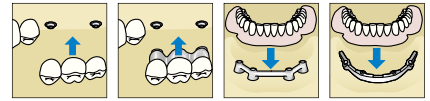

# Bar-supported dentures and bridges with Ankylos® Balance Base Abutment C/

## Laboratory-fabricated restorations with Ankylos® Balance Base Abutment C/

- Overdentures on laser welded or soldered bars in the implants
- Screw-retained bridges with ceramic or synthetic veneering for edentulous or partially edentulous jaws
- Prefabricated components facilitate a simplified procedure

## Atlantis® implant suprastructures on Ankylos® Balance Base Abutment C/

- Atlantis bar reconstructions and bridgework with centrally fabricated CAD/CAM frameworks
- Patient-specific implant suprastructures designed and finally approved by the dental laboratory
- Perfect, tension-free fit of restoration, even at the first fitting, even for large and complex reconstructions, thanks to the high precision computer-controlled process



1-4 | Examples of CAD/CAM-fabricated Atlantis bars.

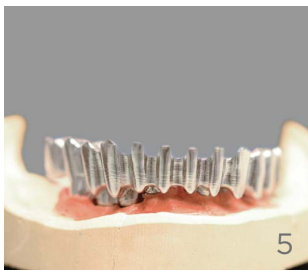

5-8 | Occlusally screw-retained Atlantis CAD/CAM bridge on six implants and Ankylos Balance Base Abutments, narrow (courtesy of Dr. Daniel Grubeanu, Trier, Germany).

# Prosthetic components for Balance Base Abutment C/

With a view towards an optimal functional and esthetic result for screw-retained bridges and bar solutions, the Ankylos Balance Base abutment range has been extended by a diameter-reduced variant.

There are two options available for the fabrication of prosthetic restorations:

- On the implant level with selection of the prosthetic abutments in the laboratory
- On the abutment level with the patient's early incorporation of the abutments



Retention copings for impression on abutment level for Balance Base Abutment narrow (left) and Balance Base Abutment (right)

From left to right: Ankylos Balance C/ implant analog, Ankylos analog for Balance Base Abutment narrow and Ankylos soldering post for Balance Base Abutment

## Impressions on implant level

### Ankylos Transfer Post (PickUp Technique)

- For transferring the implant position to the master cast using the PickUp technique (open tray)
- Available in two lengths
- One piece with integrated straining screw, screw extension included

### Ankylos Transfer Post (Repositioning Technique)

- For transferring the implant position via repositioning technique (closed tray)
- Available in two lengths
- One-piece, with integrated straining screw

## Impressions on abutment level

### Ankylos Retention Coping for Balance Base Abutment narrow and Balance Base Abutment

- For simplified impression-taking on the abutment level, giving an increased precision for CAD/CAM prosthetics
- Screw retention with M 1.6 mm occlusal hex fixation screw (blue anodized)
- With extra long fixation screw (order no. 3105 6025) also for transferring abutment position using the open tray technique

## Model fabrication

### Ankylos Balance C/ Implant Analog

- For attaching the prosthetic components in the master cast
- Surgical steel

### Ankylos Analog for Balance Base Abutment narrow

- For attaching the prosthetic copings onto the master cast when working on the abutment level (after taking the impression with the retention coping)
- Surgical steel

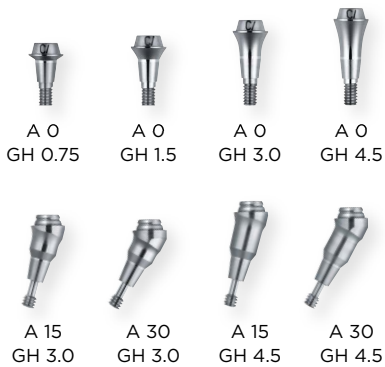
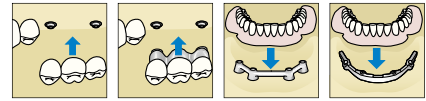

Ankylos Balance Base Abutment C/ narrow (above) and Balance Base Abutment C/ angled (below)

Diameters / head- / gingival heights

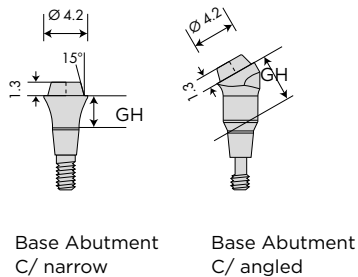

Dimensions Ankylos Balance Base Abutment C/ [mm]

### Ankylos Soldering Post (model analog) for Balance Base Abutment

- For attaching the bar construction on the soldering model
- Can be used for restorations on the abutment level (after taking the impression with the retention coping) and as a model analog for the Balance Base Abutment C/
- Surgical steel

### Prosthetic restoration

#### Ankylos Balance Base Abutment C/ narrow

- For attaching overdentures on bars and screw-retained bridges
- Also for CAD/CAM bars and bridges
- Four gingival heights allow adjustment to the clinical situation
- Only for occlusal screw retention
- Screw retention with M 1.6 mm occlusal hex fixation screw (order no. 3105 6022, blue anodized)

# Prosthetic components Balance Base Abutment C/

Prefabricated copings are available for the easy preparation of prosthetic restorations on the Ankylos Balance Base Abutment C/ narrow without the need for changing components in the patient's mouth.



Prefabricated copings for Ankylos Balance Base Abutment narrow and Balance Base Abutment: retention copings (left), gold copings (center) and wax-up copings (right)

## Prosthetic restoration

### Ankylos Retention Coping for Balance Base Abutment narrow

- For fabricating long-term provisionals by polymerizing the coping into the prosthesis
- Screw retention with M 1.6 mm occlusal hex fixation screw (blue anodized)

### Ankylos Copings for Balance Base Abutment narrow

- For laser-welded or soldered bars
- As a cast-on base for bridges
- High gold-content Permador PDF alloy
- Screw retention with M 1.6 mm occlusal hex fixation screw (blue anodized)

### Ankylos Wax-up Copings for Balance Base Abutment narrow

- For modeling bridges
- Made from castable synthetic material POM
- Retention with M 1.6 mm occlusal hex fixation screw (blue anodized), must be ordered separately

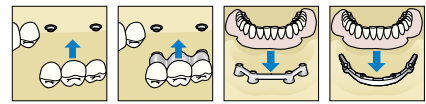

Titanium coping and fixation screws for Balance Base Abutment C/ narrow:  
Ankylos M 1.6 mm occlusal hex fixation screws, short, long, extra long and 19 mm



From left to right: Ankylos insert for prosthetic ratchet 1.8 mm hex, Ankylos 1.0 mm hex laboratory screwdriver and Ankylos screwdriver handle

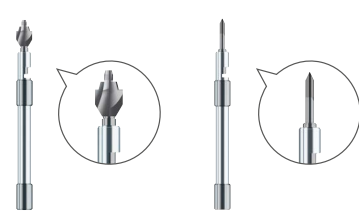

Ankylos finisher for elaboration of the prosthetic restoration

### Ankylos Titanium Coping for Balance Base Abutment narrow

- For laser welding
- Cylindrical geometry
- Manufactured from grade 4 titanium
- Delivered without fixation screw

### Ankylos M 1.6 mm Occlusal Hex Fixation Screw for Balance Base Abutment narrow

- Available in three lengths
- Short (order no. 3105 6022), blue anodized
- Long (order no. 3105 6024), locks onto the cap
- Extra long (order no. 3105 6025), projects 5 mm out of the coping, can also be used with the retention coping, for taking the impression of the abutment position with an open tray

## Instruments

### Ankylos Insert for Prosthetic Ratchet, 1.8 mm Hex

- For screw-retaining the Ankylos Balance Base Abutments C/ with the implant analog
- Torque: 25 Ncm

### Ankylos 1.0 mm Hex Screwdriver

- For screwing in the 1.6 mm occlusal hex fixation screw
- Reduced torque: 10 Ncm

### Ankylos Finisher for Balance Base Abutment narrow

- For elaborating the surface layers of bridge constructions
- One instrument each for Balance Base Abutment C/ and Balance Base Abutment C/ narrow

### Ankylos Finisher for Taper Occlusal Retention Screw

- For smoothing the screw channel for occlusally screw-retained structures

# Step-by-step: Conventionally laboratory-fabricated bar restoration (laser-welded)

## Casting the model after taking the impression with the Ankylos Balance C/ transfer post

The impressions for suprastructures on Ankylos Balance Base Abutments C/ are made on the implant level with Ankylos Balance transfer posts PickUp (open tray) or repositioning technique with the C/ marking.

The impression and the components used, including the screws, are handed over to the laboratory. The components are attached onto Ankylos Balance C/ implant analogs. The model is then fabricated as usual.

### Bar - laser-welded

### Bar - soldered

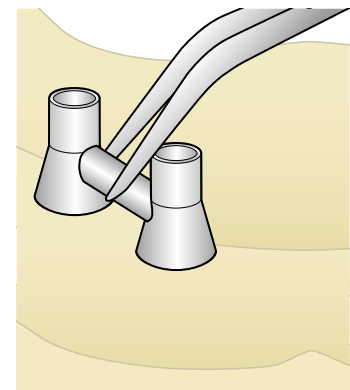
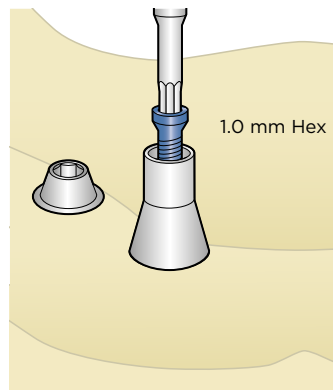
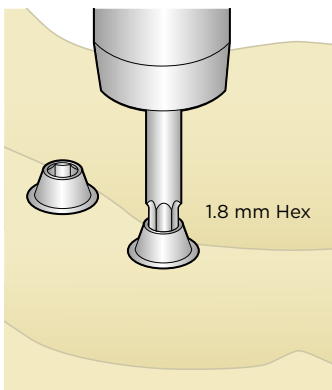

## Screwing in the Ankylos Balance Base Abutments

Screw the Ankylos Balance Base Abutments C/ or Base Abutments C/ narrow hand-tight into the implant analogs of the bar model using the 1.8 mm prosthetic hex ratchet.

If the impression has been taken using retention copings, this step is omitted. In this case, the position of the abutments is shown by the analogs (Balance Base Abutment narrow) or the soldering post (Balance Base Abutment) located in the model.

## Attaching the gold copings

Fit the Degunorm Ankylos gold copings for Balance Base Abutment to the abutments and attach using a corresponding screw (see page 45).

The Base Abutment must not be inserted with the 1.0 mm hex insert as this will damage the thread.

## Adjusting the bars

Adjust the bars to the spaces between the gold copings. Keep gaps between the bar and the gold copings as narrow as possible.

The bar is manufactured by laser-welding (page 47) or soldering (page 48).

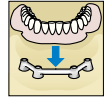

### Casting the model after taking the impression with the retention coping

As an alternative, an impression of the abutment position can be taken, using the Ankylos retention coping for Base Abutment or Base Abutment narrow. In this case, the Ankylos Balance Base Abutments C/

will have already been fitted into the patient's mouth. The model is made using Ankylos analogs (Balance Base Abutment narrow).

### Bar - laser-welded

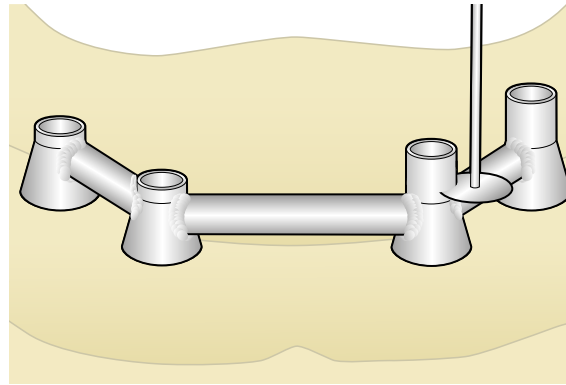
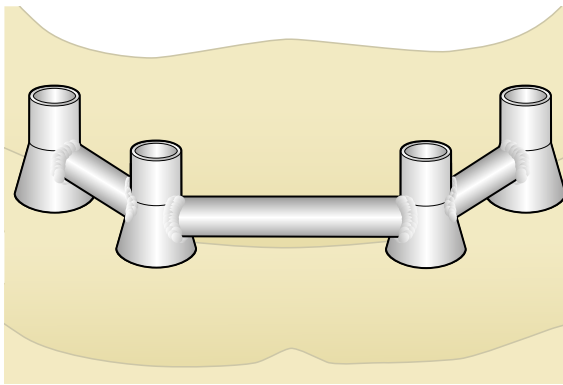

### Bar - laser-welded

When laser-welding, observe the laser welding parameters according to the alloy used.

Then, adjust the height of the gold copings.

A passive, tension-free fit should be ensured when manufacturing bar constructions, as otherwise, problems such as loosening or fracture of the screws may arise after the prosthesis has been worn for a certain period.

# Step-by-step: Conventionally laboratory-fabricated bar restoration (soldered)

For the fabrication of soldered bars, it is necessary to produce a soldering model for attaching the bar during soldering. Ankylos soldering posts (for Balance Base Abutment) or analogs (for the Base Abutment narrow) are used in the soldering model.

## Bar - soldered

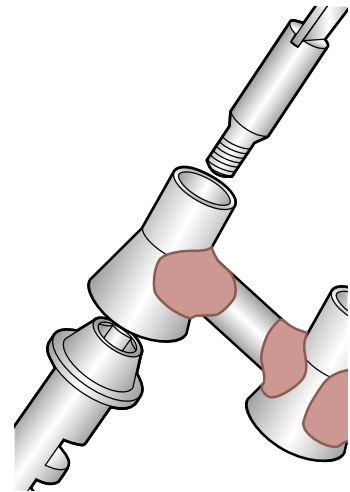
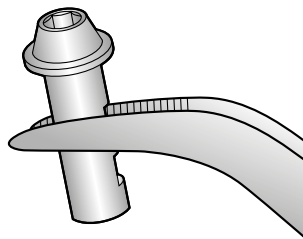
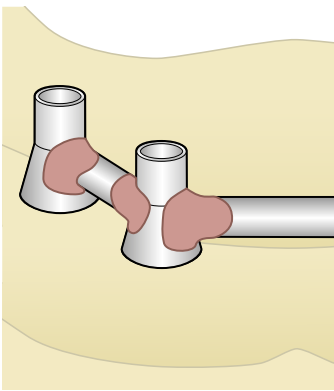

### Bar - soldered: Attaching the bars for soldering

Abrade the gold copings in situ to obtain a better bond when attaching the bar copings to the bars using modeling compound. Check the hygienic capability of the construction.

### Oxidizing the soldering posts (analogs)

Oxidize soldering posts or analogs by flame.

### Screw-retaining soldering posts (analogs)

Detach the bar construction from the model and screw the soldering posts onto the structure using wax-up screws (order no. 3104 5211/short and 3104 5213/long). Analogs are used for restorations on Balance Base Abutment C/narrow, to which the construction is screwed using M 1.6 mm occlusal hex fixation screws (order no. 3105 6022/24/25/26). The fixation screws for later use in the mouth must not be used for the soldering.

A passive, tension-free fit should be ensured when manufacturing bar constructions as otherwise, problems such as loosening or fracture of the screws may arise after the prosthesis has been worn for a certain period.



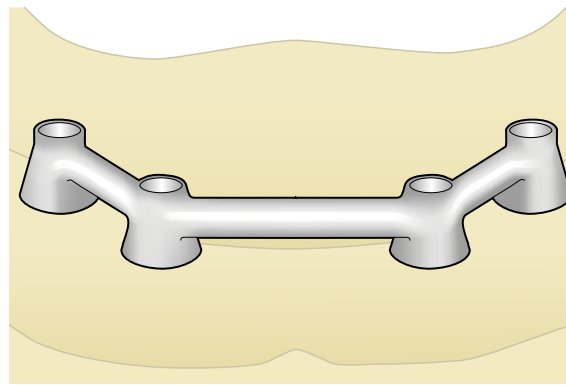
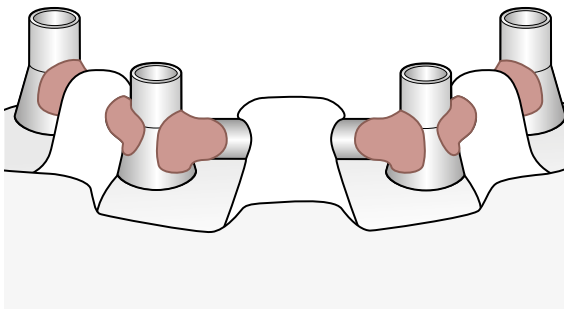
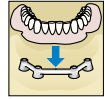

### **Fabrication of the soldering model    Try-in on the model**

Fabricate the soldering model using investment compound. The soldering model should be kept as small as possible.

#### **Soldering the bar**

Fire the modeling compound and introduce DS 1 or T soldering flux into the soldering gap. The flux must not make its way into the screw channel (solder for Degunorm, solder for HSL).

The soldered structure is pickled in the Neacid pickling unit, checked for accuracy of fit on the master cast and the height of the gold copings is adjusted.

The restoration is then elaborated and polished.

# Step-by-step: Conventionally laboratory-fabricated bar restoration

After the bar construction has been completed, the prosthesis is fabricated.

## Bar - laser-welded

## Bar - soldered

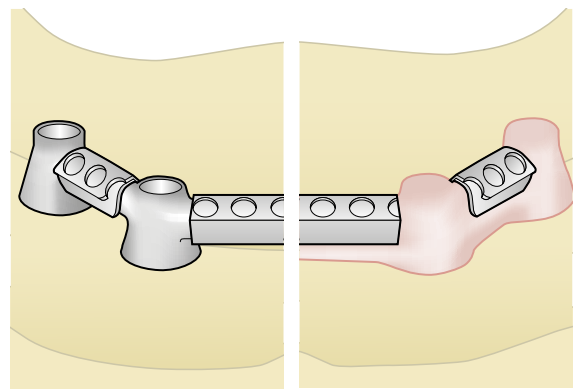
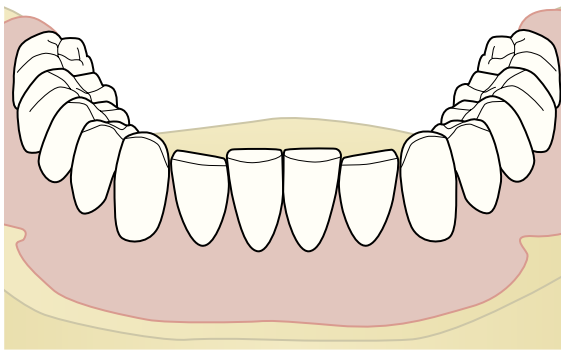

### Wax-up

Wax up the teeth over the gold copings and bars, then check fit.

### Adjust the bar slides

Trim the activatable bar slides appropriately prior to completing the bar prosthesis. There should be a clearance of approximately 0.5 mm to the bar copings.

### Splinting before completion

Splint the bar construction, leaving the retention section free.

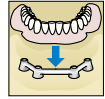

### Please note the following directions for dental alloys:

**Side effects:** Both allergies to the metals in the alloys and electrochemical paresthesias may occur. Instances of systemic side effects of metals in the alloy have been reported.

**Interaction:** Avoid occlusal and approximal contact of different types of alloy.

**Contraindications:** Demonstrated hypersensitivity to a metal in the alloy.

In addition, please observe the manufacturer's directions.

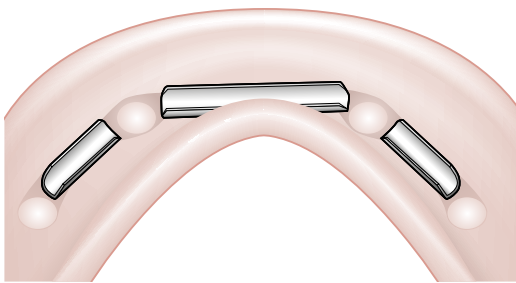

### The completed bar prosthesis

Complete the bar prosthesis as usual. Activate or deactivate the bar slides according to the desired retentive force. For delicate prostheses, a metal reinforcement is necessary to minimize the risk of breakage.

The original abutments are handed over to the practice, along with the bar construction and prosthesis.

New fixation screws should always be used to fit the Ankylos Balance Base Abutments into the mouth: order no. 3105 6022 (blue).

# Step-by-step: Conventionally laboratory-fabricated bridge (screw-retained)

The impressions for suprastructures on Ankylos Balance Base Abutments C/ on the implant level are taken with Ankylos Balance transfer posts PickUp (open tray) or repositioning technique with the C/ marking. The impression and the components used incl. screws are handed over to the laboratory. As an

alternative, an impression of the abutment position can be taken using the Ankylos retention coping for the Base Abutment. For guidelines on this, see pages 44/45.

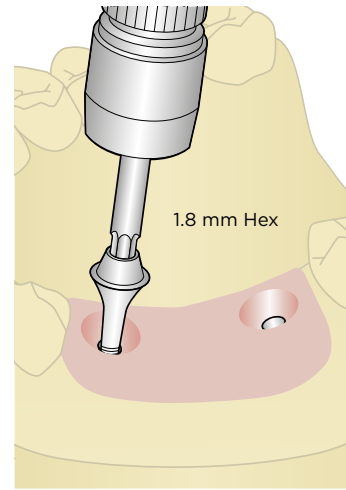
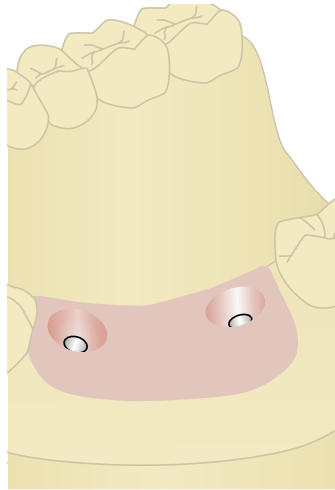
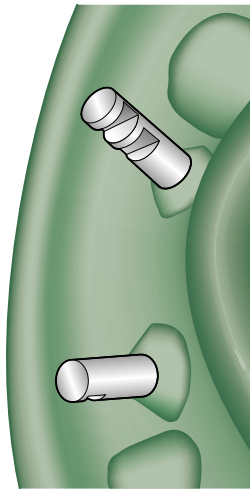

## Fixing the implant analogs

Screw the Ankylos Balance C/ implant analogs into the transfer posts fixed in the impression by using the transfer screws. A removable mucosa mask will simplify correct modeling of the interdental spaces.

## Casting the model

Fabricate the model using dental stone class IV. Here, ensure an adequate height, such that the implant analog covered with plaster. Then remove the transfer screws and the impression.

## Screw in the Ankylos Balance Base Abutments C/

Screw Ankylos Balance Base Abutments C/ into the implant analogs by using the 1.8 mm hex insert for the prosthetic ratchet. The gingival height of the abutments is already simulated by the sulcus former.

If the impression has been taken using retention copings, this step is omitted. In this case, the position of the abutments is shown by the analogs (Balance Base Abutment narrow) or the soldering posts (Balance Base Abutment) located in the model.

The Base Abutment must not be inserted with the 1.0 mm hex insertion as this will damage the thread.

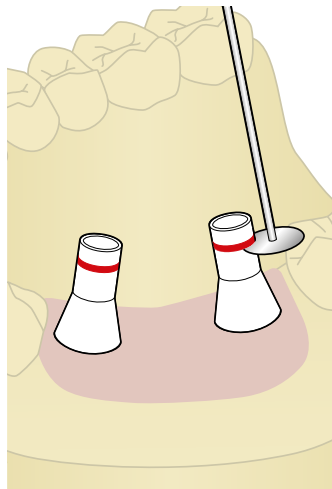
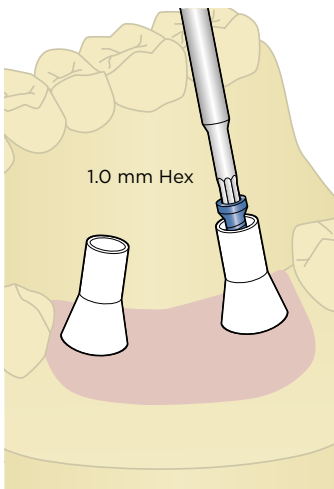
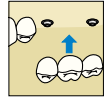

### Attaching the wax-up copings

Attach the Ankylos wax-up copings for the Balance Base Abutment C/ or Balance Base Abutment C/ narrow by using the blue occlusal fixation screw.

### Adjusting the wax-up copings

Mark the model height on the screw channel. Using a thin cutting disk, trim the screw channel and check the height of the occlusion.

Screw-retained restorations only may be produced on Ankylos Balance Base Abutments, since the abutment height of the heads does not provide adequate retention for cementing.

# Step-by-step: Conventionally laboratory-fabricated bridge (screw-retained)

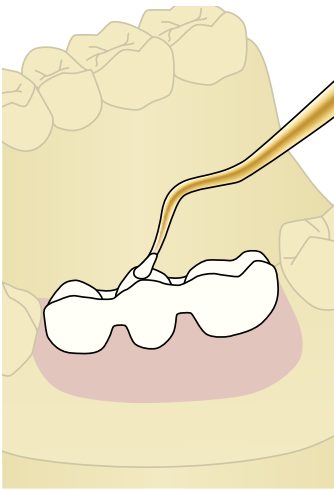

## Wax-up

Wax up and invest the bridge as usual. Ensure adequate interdental spaces for hygienic capability.

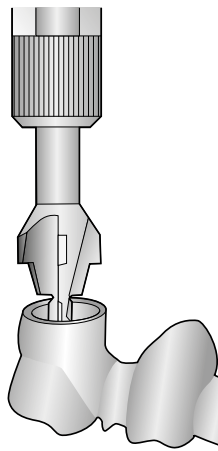

## Elaborating the framework

Finishers are available for elaborating the inner surface of the taper and of the screw channel.

The supporting surfaces of the bridge construction on the Ankylos Balance Base Abutments are smoothed with the Ankylos finisher for Base Abutments 4.2 mm or 5.5 mm.

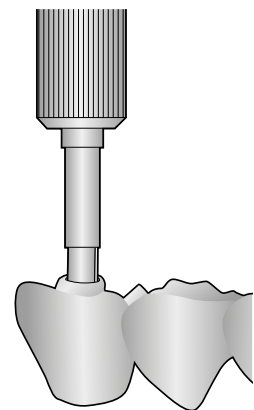

Use the Ankylos finisher for taper occlusal retention screw to remove rough areas in the screw channel. Insert the finisher into the screw channel and twist carefully, until the surface is shiny and smooth.

Ankylos Balance Base Abutments must not be ground or modified, these may have another alignment in the mouth.

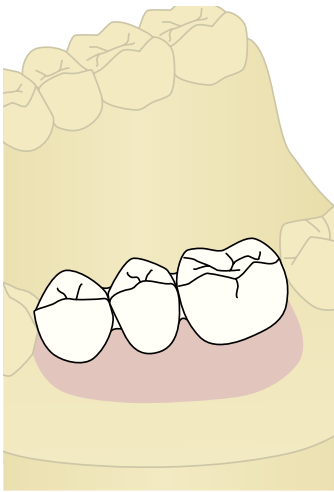
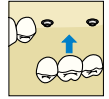

## Veneering

Veneer the bridge as usual and check the interdental spaces are adequate for hygienic capability.

The original abutments as well as the suprastructure are handed over to the practice. New fixation screws should always be used to fit the Ankylos Balance Base Abutments into the mouth; order no. 3105 6022 (blue).

# CAD/CAM-fabricated suprastructures

The advantage of CAD/CAM-fabricated Atlantis implant suprastructures in comparison with cast structures is in the consistent quality of the metal framework. As a result, particularly for larger spans, an absolutely tension-free fit is achieved.

Using the milled Atlantis implant suprastructures, restorations can be fabricated on narrow Ankylos Balance Base abutments C/ on between two and a maximum of ten implants. For Ankylos, the structures are always fabricated on abutment level and mounted with occlusal screws.



A precise impression as a basis for the master cast is crucial for the precision of the restoration.

Atlantis implant suprastructures are milled only after review and final approval of the CAD design in Atlantis Viewer.

Atlantis offers a full range of implant suprastructures:

- Atlantis 2-in-1 and bar structures for removable prostheses
- Atlantis bridge and hybrid structures for fixed prostheses

Atlantis implant suprastructures are designed and produced according to the dental technician's specification, using the latest developments in CAD/CAM technologies, and supported by computer based industrial and medical device expertise.

## Atlantis step-by-step

### 1. Ordering

An implant/abutment level impression is taken by the clinical customer and sent to the laboratory with a request for Atlantis.

### 2. Entering

An order is entered via Atlantis WebOrder and the stone model, together with the diagnostic tooth set-up, are sent to the Atlantis production unit.

### 3. Scanning

The stone model and diagnostic tooth set-up are scanned in 3D at the production unit.

### 4. Designing

The suprastructure is designed by the Atlantis CAD department using the latest digital technologies.

### 5. Viewing

The design is reviewed and approved, by the customer, in Atlantis Viewer prior to manufacturing.

### 6. Manufacturing

The suprastructure is milled at the production unit following an individual milling strategy.



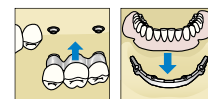

After design approval, the structure is milled at Atlantis according to a customized milling program.

After delivery of the milled structure, the dental laboratory fabricates the bar prosthesis or veneers the bridge framework.

### 7. Verifying

The suprastructure is inspected and verified at the production unit against the stone model and tooth set-up.

### 8. Shipping

The final suprastructure is shipped to the laboratory.

Atlantis implant suprastructures can be fabricated using a CoCr alloy or a pure titanium grade 4.

	Cobalt-chrome alloy	Pure titanium
Composition	In accordance with EN-ISO 22674	Type: Grade 4, ASTM B265
	Cobalt 54.1% Chrome 20.0% Tungsten 16.4% Niobium 0.2% Iron 7.5% Silicon 1.5% Manganese 0.3%	Titanium As well as Nitrogen 0.01% Carbon 0.02% Hydrogen 0.004% Iron 0.03% Oxygen max. 0.31% (total 100%)
Therm. Exp. Coeff. (25-500 °C)	14.6 10 <sup>-6</sup> K <sup>-1</sup>	9.6 10 <sup>-6</sup> K <sup>-1</sup>
Therm. Exp. Coeff. (25-600 °C)	14.9 10 <sup>-6</sup> K <sup>-1</sup>	-
Melting range / melting point	1.390 °C - 1,410 °C	1,670 °C
Density	9.1 g/cm <sup>3</sup>	4.5 g/cm <sup>3</sup>
Vickers hardness	280 HV10	170 HV10
0.2% proof stress	550 N/mm <sup>2</sup>	493 - 499 N/mm <sup>2</sup>
Tensile strength	710 N/mm <sup>2</sup>	598 - 605 N/mm <sup>2</sup>
Breaking strain	12%	23 - 27%
Elasticity modulus	200 GPa	110 GPa

# Step-by-step: Impressions and model casting for CAD/CAM restorations

A precise stone model made in the laboratory, which reproduces the clinical situation exactly, is crucial for the perfect fit of a CAD/CAM-fabricated implant suprastructure, even at the first fitting. An absolutely precise impression of the clinical situation is essential for this.

This should take place over several consultations and in close cooperation with the laboratory. To better illustrate the closely linked working steps between the practitioner and the dental technician, the procedures involved both in the dental practice and the laboratory are depicted here.

## Dental practice

## Dental laboratory

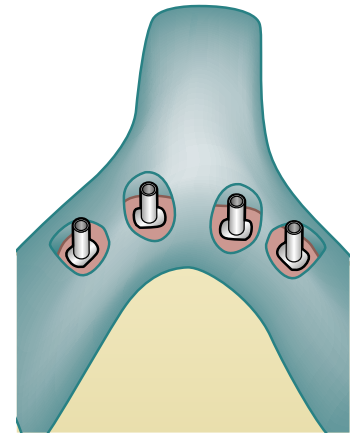
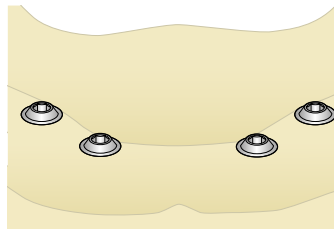
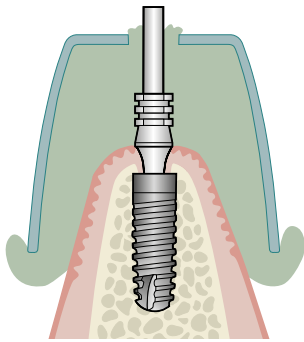

### First consultation: Impression for situation model

The first impression is taken using the PickUp technique via retention caps. Subsequently, the gingiva forming components are again fitted until the second consultation, e.g. the Ankylos protective cap narrow.

The impression is handed over to the laboratory with all the components used.

### In the dental laboratory: Fabrication of the situation model

A situation model is made from the impression. Depending on which components are used for impression taking, analogs (for retention copings) or implant analogs (for repositioning posts) are used. Balance Base Abutments C/ or Base Abutments C/ narrow are located in the analogs.

### Individual tray

Based on this model, a customized tray for the pick-up technique is manufactured. Adequate space for the impression material must be ensured while manufacturing the tray.

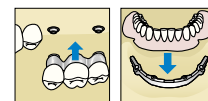

It is from this second impression of the intraoral splint that the laboratory fabricates the master cast, and on it, the wax-up.

## Dental practice

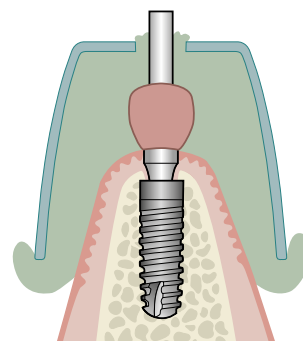
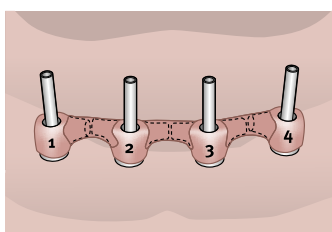
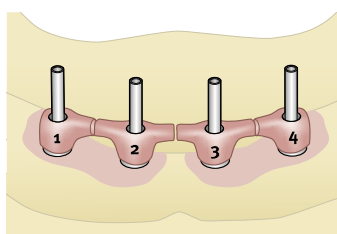

### Fabrication of primary splint

Retention copings matching the diameter of the abutment are used for manufacturing the primary splints, which are attached to the analogs or the abutments with the respective screws:

M 1.6 mm occlusal hex fixation screw, extra long (order no. 3105 6025) for retention copings, narrow, or wax-up screws (order no. 3104 5211/short and 3104 5213/long) for 5.5 mm diameter retention copings. The autopolymer resin splinting is divided into separate segments and is sent to the practice for intraoral splinting and impression.

### Second consultation: Intraoral splinting of the synthetic elements

The practitioner attaches the separate synthetic primary splint segments delivered from the laboratory onto the Balance Base Abutments using the fixation retaining screws. By doing so, an adequate gap between the separate segments should be ensured. Where there is contact, grind off the synthetic material. Then, the tension-free synthetic segments are splinted intraorally using the same autopolymer used by the laboratory.

### Splint impression

The impression is then taken on top of the now splinted retention copings using impression material and the customized tray. After the dental impression material has set, the fixation screws can be undone and the entire tray removed.

This high precision impression is sent to the laboratory to fabricate the master cast, and on it, the wax-up.

# Step-by-step: Impressions and model casting for CAD/CAM restorations

## Dental laboratory

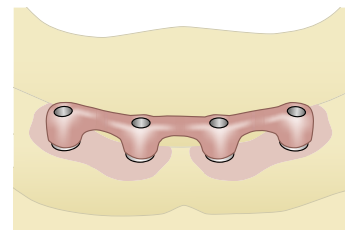
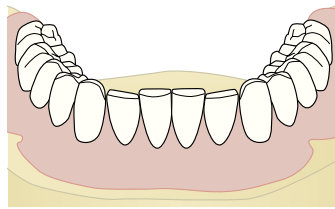
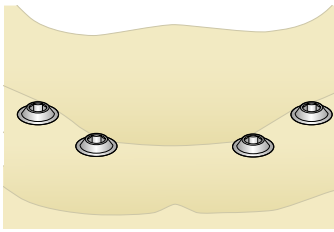

### In the dental laboratory: Producing the master cast

The laboratory produces the master cast based on the impression of the intraorally splinted retention copings. This stone model is crucial for the subsequent precise fit of the suprastructure.

### Wax-up

A wax mock-up with tailored teeth is made on the master cast.

### Preparing the transfer key

A transfer key is again manufactured from autopolymer in order to be able to compare the implant positions in the master cast with the clinical situation. This key is finally splinted in the laboratory.

The wax-up and the transfer key are sent to the dental practice for intraoral checking.

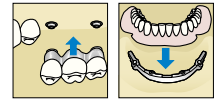

## Dental practice

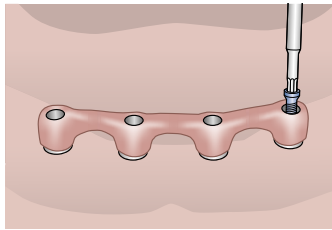
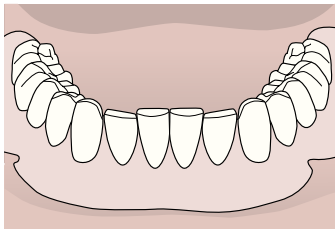

### Third consultation: Try-in of wax-up and Sheffield Test

In the third consultation, the practitioner checks the wax mock-up with tailored teeth made by the laboratory on the master cast in the patient's mouth in respect of function and esthetics and corrects it if necessary.

The autopolymer transfer key made by the laboratory, which is used for comparison of the implant position in the master cast with the clinical situation, is checked intraorally for a tension-free fit by means of the Sheffield Test.

Provided no fitting problems appear or these have been corrected, the laboratory will order the Atlantis implant suprastructure via [www.atlantisweborder.com](http://www.atlantisweborder.com) after approval of all components by the practice.

### Sheffield Test

The Sheffield Test facilitates a simple check of the fit of a primary splinted mesiostructure on implants. After the structure has been positioned, each fixation screw is tightened separately while the other screws are not screwed in. Thus, the structure is only attached to one implant each time.

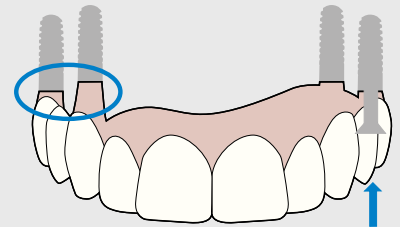

When a screw is tightened, a tension-free framework will remain resting on all of the implants.

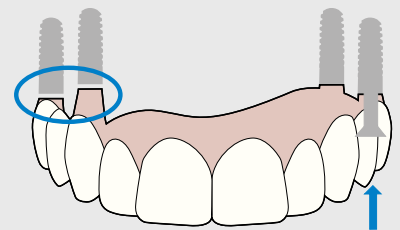

If the structure is not tension-free, a gap will be formed between the implants not screw-retained and the structure or this will change.

# Step-by-step: Planning and fabrication of the Atlantis implant suprastructure

Atlantis implant suprastructures are ordered through the Atlantis WebOrder system: [www.atlantisweborder.com](http://www.atlantisweborder.com)

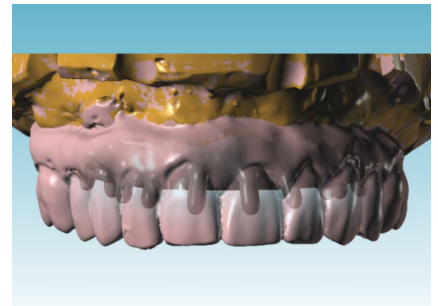

Photo: Carsten Fischer, Sirius Ceramics

## Ordering

After placing the order via Atlantis WebOrder, the stone model, together with the diagnostic tooth set-up, is sent to the Atlantis production unit.

## CAD design proposal

The model and the wax-up are scanned in 3D at Atlantis using a state of the art industrial structured light scanner. A design proposal is prepared in accordance with your specification, using the latest digital technologies that allow even the most complicated cases to be resolved with confidence. There is almost no limit to the size, type and number of implants and attachments using this software.

## Review using Viewer software

24 hours after receipt of the model at Atlantis you will receive your particular construction proposal online. You will receive the free Atlantis Viewer software with the proposal, with which you will be able to evaluate the construction in 3D.

You can discuss potential requests for adjustment directly with the dental technicians at Atlantis, who will implement these directly.

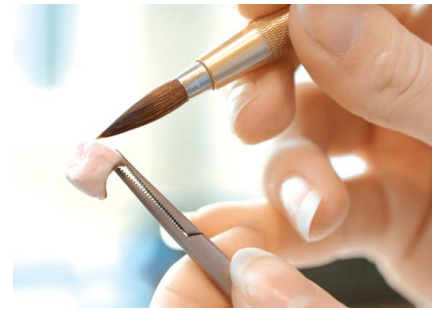
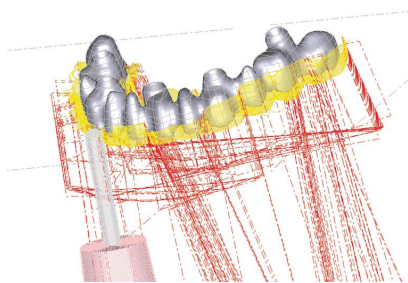
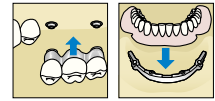

### Planning the CAM milling strategy

After approval of the supra-structure design, the Atlantis engineers develop an individual milling strategy for each case. Atlantis milling strategies have been optimized to produce a precise and tension-free fit.

### Milling the structure

Then, depending on the material guidelines, the titanium or cobalt-chrome construction is milled at the Atlantis manufacturing facilities. All milling machines are routinely quality controlled and inspected in accordance with quality systems regulations. Before being shipped to the laboratory, all suprastructures are verified and inspected.

Atlantis will send the milled structure to the dental laboratory, together with the master cast and the wax-up. The Ankylos occlusal fixation screws required for attaching the bar construction or bridge in the mouth are included.

### Processing in the dental laboratory

After delivery of the milled structure, the dental laboratory fabricates the bar prosthesis or veneers the bridge framework. The completed restoration, together with the fixation screws, is handed over to the practitioner for fitting.

# SynCone<sup>®</sup> C/

A metal-reinforced prosthesis on Ankylos SynCone C/ 5° tapered crowns is an innovative solution for providing the prosthesis with a tension-free fit (passive fit). However, this can only be guaranteed by intraoral bonding of the components fabricated in the laboratory.

For the patient, the maximum possible reduction of the prosthetic body provides highest wearing comfort and excellent hygienic capability.



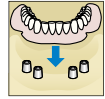

# Overdentures on Ankylos® SynCone® C/

## Ankylos® SynCone® metal-reinforced prosthesis

A metal-reinforced prosthesis is fabricated for the final restoration of the patient

- As a replacement for the long-term temporary denture after healing of the implants placed for immediate loading
- As part of the two-stage procedure after submerged implant healing

The advantages:

- Tension-free seating (passive fit) with intraoral cementing of the taper cap to the framework
- Simplification with prefabricated components for chairside procedure
- Prosthesis retention is superior to a bar milled by a time-consuming process and also much more economical
- Improved hygiene for patients

## Ankylos® SynCone® long-term temporary denture

Within the context of an immediate restoration of the patient, a long-term temporary prosthesis can be fabricated chairside immediately after insertion of the implants. Therefore, an existing prosthesis is prepared accordingly by the dental laboratory (see page 69).



1-5 | Metal-reinforced SynCone restoration of the edentulous mandible on healed implants (courtesy of dental laboratory Alt & Schmidt, Lünen/Germany).

# The tapered crown principle

Ankylos SynCone transfers the clinically proven stability of the tapered abutment connection to the abutment-prosthesis connection. This second tapered connection ensures that the final restoration is tightly seated minimizing gaps and micromovement. Compared with bar restorations or other prefabricated connecting components, SynCone tapered crowns offer a stable and friction-locked connection that helps to eliminate problems often associated with edentulous jaws, such as:

- Pain of pressure of ill-fitting dentures
- Atrophy as a result of inactivity or pressure
- Continued bone loss requiring relining of existing denture
- Design-related difficulties with the mesostructure

A connection with a tapered cone design serves as a retaining element where the tapered cap is retained on a tapered abutment by surface contact. When the retention is disconnected, the prosthesis is released, allowing for easy removal. In contrast, a parallel-walled, telescopic design creates a friction throughout the complete path of insertion.

Patients find it easier to insert a prosthesis with tapered connection design, because the bottom diameter of the tapered caps connected to the denture is always larger than the top diameter of the abutments.

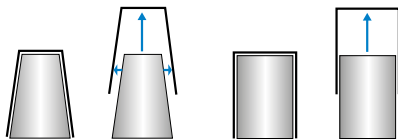

Simplified insertion and removal of the prosthesis with tapered abutments (left) in comparison with parallel-walled retaining elements (right)

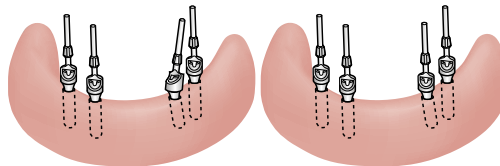

Creation of a common direction of insertion for abutments with non-indexed, tapered connection

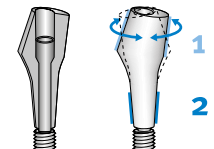

Abutment heads (1) can be freely rotated due to the connection taper (2).

## The synergy of the two tapers

The tapered TissueCare connection allows for free 360° alignment of the non-indexed abutments in any position. This enables aligning angled abutments by rotation until the insertion direction of the prosthesis has been reached (staggered-taper principle).

Ankylos SynCone abutments have an integrated, mobile straining screw so that the taper of the abutment head can be rotated in the connection taper of the implant as needed to form a common direction of insertion.

## Advantages for patients

The tapered crown principle effectively makes the prosthesis into a removable bridge with:

- Very high stability
- High chewing comfort
- Reduced prosthesis base
- Improved phonetics
- Optimum hygiene capability



# Prosthetic components Ankylos® SynCone® C/

The abutments for the Ankylos SynCone treatment concept are only available with non-indexed tapered connection geometry, as free positioning of the abutments is essential.

All Ankylos SynCone C/ components are laser-marked with a "C/" as in "C"onus according to their intended use.



Ankylos Balance C/ transfer post with screw and Ankylos Balance C/ repositioning post



Ankylos SynCone C/ abutment 5°, straight and angled, cover screw for straight abutment

Diameters, angulations and head heights Gingival heights

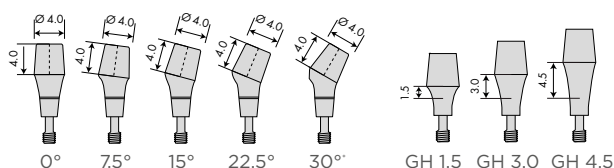

Dimensions Ankylos SynCone C/ abutment [mm]

## Impressions

### Ankylos Balance C/ Transfer Post

- For transferring the implant position to the master cast using the PickUp technique (open tray)
- Available in two lengths
- Two-piece with separate screw

### Ankylos Balance C/ Repositioning Post

- For transferring the implant position to the master cast using the repositioning technique (closed tray)
- Repositioning post narrow for cases with limited space available
- One-piece with integrated thread

## Model fabrication

### Ankylos Balance C/ Implant Analog

- For fixing the prosthetic components in the master cast
- Surgical steel, DIN 1.4305



## Prosthetic restoration

### Ankylos SynCone C/ Abutment

- For the restoration of the edentulous mandible with an immediate or delayed loaded prosthesis on four prefabricated tapered abutments placed intraforaminally
- For the restoration of the edentulous maxilla on six osseointegrated implants
- Abutments with 5° tapered angle, adaptable to the clinical situation via three gingival heights (1.5/3.0/4.5 mm) and five angulations (0°, 7.5°, 15°, 22.5° and 30°).
- Cover screw for straight 5° abutments must be ordered separately



Ankylos tapered cap Degulor for SynCone with (left) and without retention (right), parallelization gauge, titanium cap for SynCone 5°



Ankylos laboratory screwdriver 1.0 mm hex (left) and insertion key for angled Standard abutments (right)

## Prosthetic restoration

### Ankylos Tapered Cap Degulor for SynCone

- Caps with retention for secure attachment of an existing prosthesis to SynCone abutments
- Caps without retention for bonding to the metal base of a newly fabricated prosthesis (in delayed restoration, only for 5° abutment)
- Alloy with high gold content Degulor 3406

### Parallelization Gauge for Ankylos SynCone

- For the parallel axial alignment of the SynCone abutments
- Available for all tapered angles
- Connection for positioning key for SynCone 5°

### Ankylos Titanium Cap for SynCone 5°

- For anchoring fixed dentures on SynCone abutments

## Instruments

### Ankylos Laboratory Screwdriver 1.0 mm hex

- Reduced torque 10 Ncm
- Prevents excessive turning of straining screw

### Ankylos Insertion Key for angled Standard Abutments

- To facilitate rotation of the angled abutments via the parallelization gauges as part of the parallel alignment of the abutments
- Included in the prosthetic kit

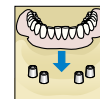

# Step-by-step: Immediate restoration with long-term temporary

In case of an existing prosthesis with optimal fit and occlusion, a patient can be restored immediately with a temporary prosthesis placed on four interforaminal implants and SynCone abutments. Therefore, the prosthesis is prepared by the dental technician prior to the surgical intervention.

The polymerization of the caps needed for attaching the prosthesis is performed chairside. Then the prosthesis is finished as a long-term temporary.

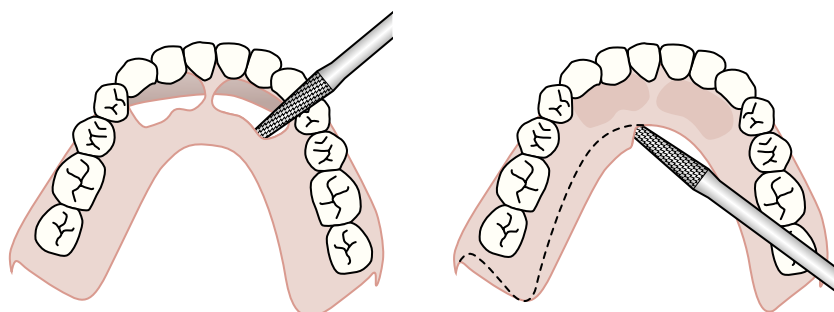

## Preparing the prosthesis

The prosthesis to be incorporated must be ground sufficiently to avoid imperfections on the caps. The drilling guide can be used as an aid here. After wound closure, an alginate impression of the inserted abutments can be taken in order to grind the prosthesis accordingly after casting the model.

This procedure is highly recommended in case of metal-reinforced prostheses. At the same time, grinding should be kept to a bare minimum to avoid excessive polymerization shrinkage.

## Shortening the functional margins

Due to the excellent retention capacity of the SynCone prosthesis on the tapered crowns, extended functional margins can be shortened to a minimum, thus achieving optimal wearing comfort for the patient.

Excess synthetic material on the prosthesis base as well as on the cap margins has to be removed.

## Fabrication of the final prosthesis with metal reinforcement

The resin of the prosthesis cannot compensate the forces transferred on the tapered caps on the long term. Therefore, a new, metal-reinforced prosthesis has to be fabricated after three to six months of immediately-loaded healing. The procedure for fabricating this laboratory-manufactured prosthesis is described on the following pages.



# Step-by-step: Model casting

## Casting the model after immediate loading

If the prosthesis is fabricated as replacement for the long-term temporary denture made from the old prosthesis, after healing of the immediately loaded implants simplified impression with SynCone caps is possible directly via the already incorporated

Ankylos SynCone abutments of the patient. The prerequisite for this, however, is that the SynCone abutments do not present any divergences or resulting parallel taper surfaces.

## After immediate loading

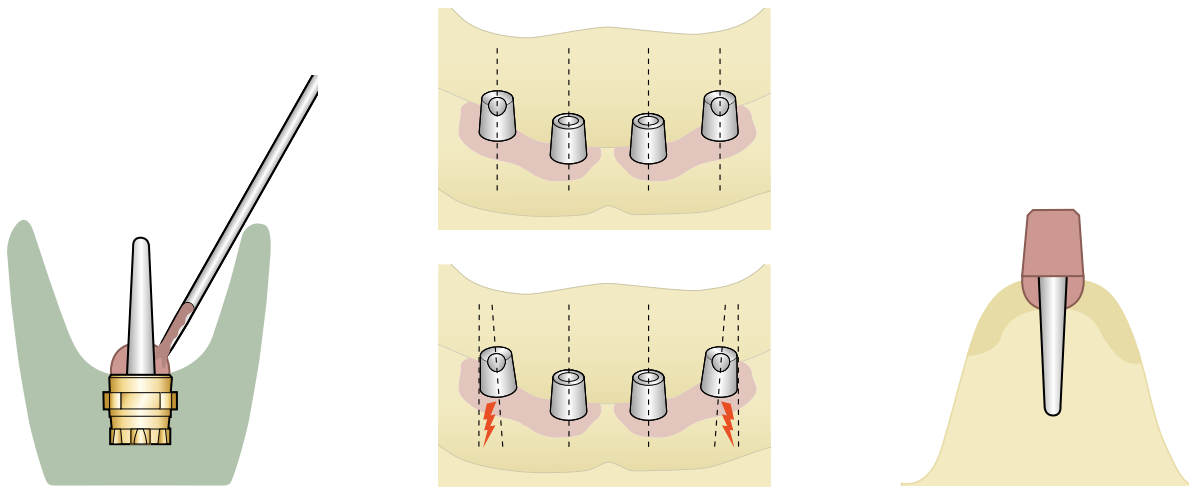

## Casting the model

To fabricate the model, insulate the inner face of the Ankylos tapered caps for SynCone if necessary, fill with self-curing liquid plastic and fit a dowel pin. Then fill the impression with dental stone.

## Check SynCone abutments

After casting the model based on the alginate impression, the replicas of the SynCone abutments are measured with a parallelometer to ensure a common direction of insertion.

Here it is to be insured that the abutments do not display any divergences or resulting parallel surfaces. After immediate loading or simplified impression via the SynCone caps, the selection and attachment of the abutments given on pages 72 – 73 is omitted. The plastic stumps created during the fabrication of the model serve as placeholders for the abutments in the model.

Please continue directly with the fabrication of the framework, see page 74.

In the case of divergences and the resulting parallel tapered surfaces, a new impression has to be taken using Ankylos Balance C/ components according to the protocol for submerged healing.

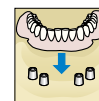

### Casting the model after submerged healing

If a prosthesis is fabricated following submerged healing, the components of the Ankylos Balance C/ prosthetic range, that is the PickUp (open tray) or repositioning transfer posts, are used for the impression.

These are fixed in the Ankylos Balance C/ implant analog.

### Following after healing

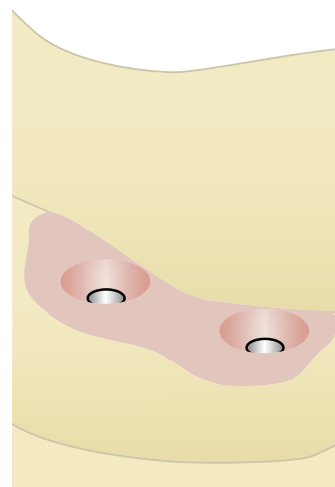
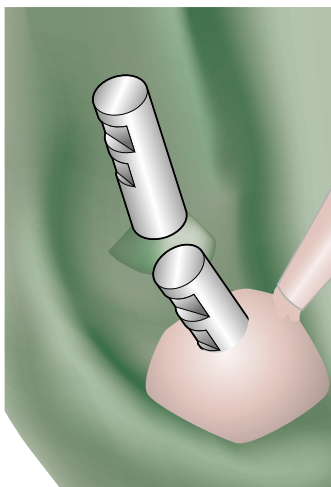
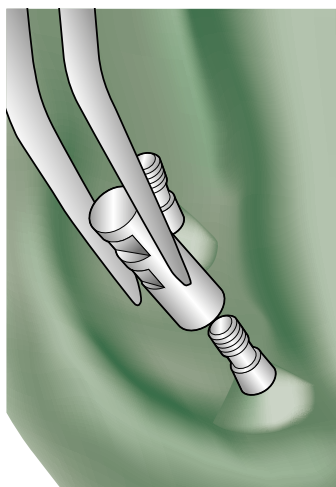

### Fixing the Ankylos Balance C/ implant analogs

Screw the implant analogs to the transfer abutments fixed in the impression using the transfer screws.

### Mucosa mask

Insulate the impression with silicone lubricant prior to casting and coat the area surrounding the implant analogs with gingiva casting material. Observe the manufacturer's instructions for use.

### Casting the model

Fabricate the model using dental stone class IV. Ensure sufficient height to cover the lower part of the implant analog with plaster. Then, undo the transfer screws and remove the impression.

Now the prosthetic abutments can be selected.

If the sulcus former is smaller than the abutment to be selected, the mucosa mask may impair the fit. In this case, fit the mucosa mask after selecting the abutment.

## Step-by-step: Selection of prosthetic abutments

In the fabrication of the prosthesis following submerged healing or after impression taking using the components of the Ankylos Balance C/ prosthetics range, the Ankylos SynCone abutments are now selected and positioned. The steps shown on these two pages are omitted in the case of immediate

loading or simplified impression via the SynCone caps, as the abutments have already been incorporated in the patient's mouth. In this case, commence directly with the fabrication of the framework, as described from page 73 onwards.

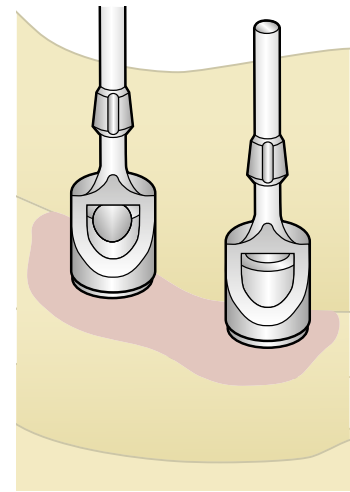
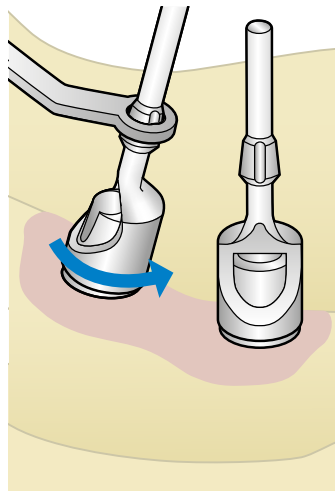
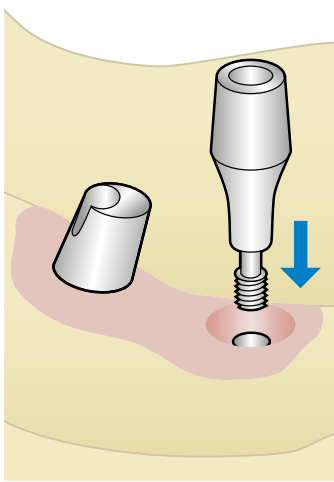

### Selection of prosthetic abutments

Select the Ankylos SynCone abutments according to sulcus height and the angulation necessary to compensate for the axial divergence of the implants. The equator of the abutments should lie slightly supragingival. Screw retain straight abutments directly using the 1.0 mm hex laboratory screwdriver; insert angled abutments only into the implant analog.

### Parallelization of abutments

Place the parallelization gauge on all abutments. For angled abutments, the parallelization gauge is to be placed such that the channel for the central straining screw can be accessed via the window.

Adjust the angled abutments to a common parallel direction of insertion in the parallelometer. Here, the insertion key for Standard angled abutments provided in the prosthetics kit can be used as an aid for turning the abutments via the parallelization gauges. This key can be attached to the shaft of the gauges.

First, screw in the 7.5°-angled abutments with the 7 mm screw handle, then remove the parallelization gauge and tighten the straining screw with 10 Ncm using the laboratory screwdriver.



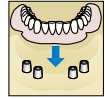

Only SynCone abutments with the same tapered angle may be used in a prosthesis. The prerequisite for a successful application of the SynCone concept is the common direction of insertion of the SynCone abutments.

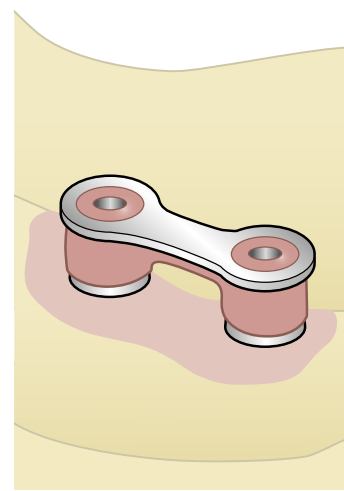
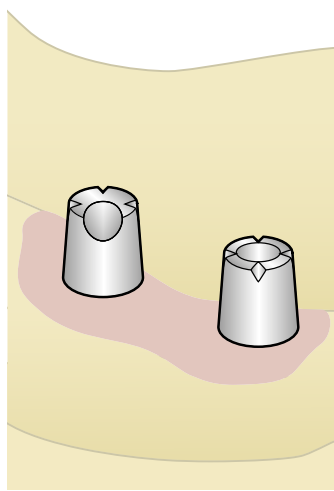
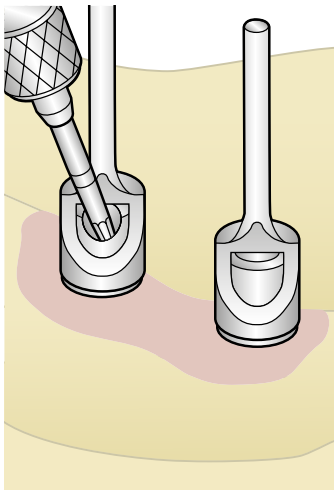

### Screw-retention of the abutments, closing the screw channel

Following parallelization, screw the angled abutments in via the window using the 1.0 mm hex laboratory screwdriver. For straight SynCone abutments with a 5° tapered angle, the screw channel hole can be sealed with the cover screw for SynCone C/ 5° abutments in the patient's mouth. For angled abutments, self-curing thermoplastics are used for this purpose.

### Marking the abutments

SynCone 5° abutments are grooved at the occlusal margin to hold these securely in the transfer key. To avoid misidentification, further small grooves can be added individually to the occlusal margin.

### Transfer key

Once the abutments have been aligned, attached and grooved, a transfer key is fabricated. This can be fabricated entirely from quick-curing synthetic material and, if necessary, provided with a metal reinforcement, which is adapted using synthetic material.

## Step-by-step: Fabrication of the metal framework

Regardless of whether the prosthesis is fabricated following submerged healing or after immediate loading on Ankylos SynCone abutments already in situ in the patient's mouth, all further steps for fabricating the framework and finishing the prosthesis are identical.

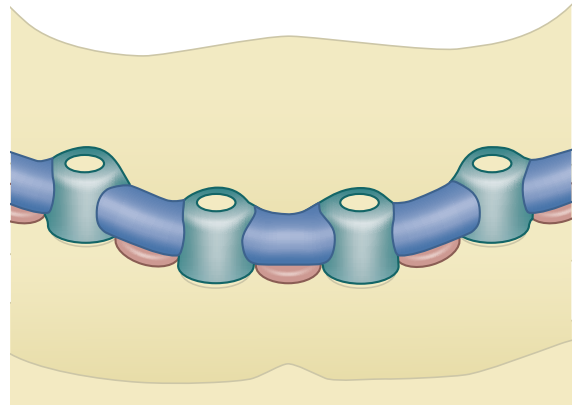
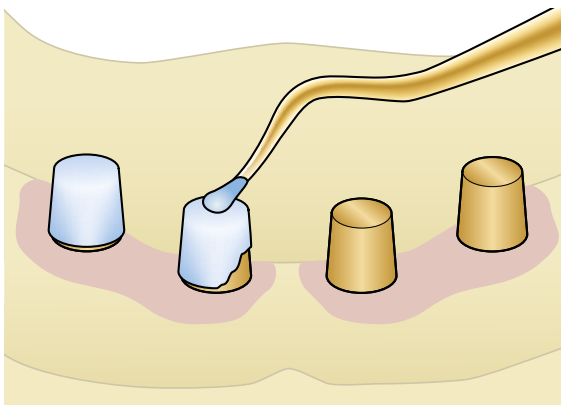

### Attaching Ankylos tapered caps for SynCone

Place the Degulor tapered caps without retention on the abutments and cover with a 0.2 mm thick layer of wax as a placeholder.

When using tapered caps with retention, the retention section of the caps should be ground off beforehand.

All undercut sections should be blocked for preparation of the duplicate model for making the cast.

### Wax-up of metal framework

The metal reinforcement, represented in the illustration as an internal reinforcement, is waxed up on the investment model. A wax-up with matrix ensures the correct position of the metal framework, a rear cover plate can be fabricated as an option.

Ensure that the connections between the cap mountings and the retentions are stable. The framework must have a clearance of 1-2 mm to the basal mucosa and should be shorter than the caps.

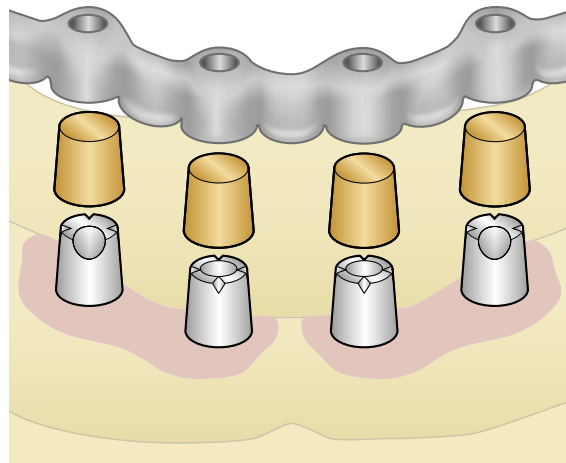
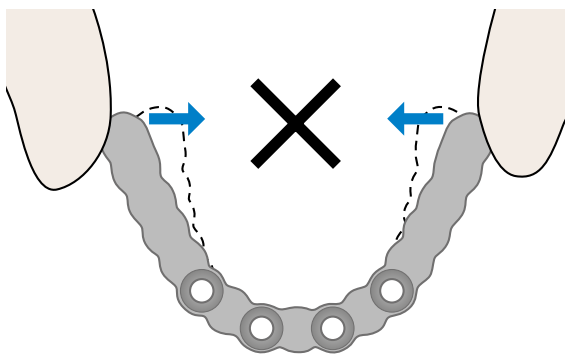
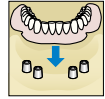

### Finishing the framework

After casting, deinvest and finish the framework. Small windows for checking the fit of the caps are placed in the occlusal edge of the caps. These allow the adhesive to escape easier during later bonding in the mouth.

### Check of stability and fit

The stability of the metal framework is checked by applying pressure on both sides of the saddles. These should not bend under pressure. The finished metal reinforcement in the model is checked for a contact-free fit on the caps. To this purpose, the caps are placed gently on the stumps and must not come off when the framework is removed.

The metal framework is bonded to the tapered caps directly in the patient's mouth to provide an optimal, tension-free prosthetic fit (passive fit). To this end, the dental laboratory will make the following preparations.

### Preparations for intraoral bonding

The exterior of the tapered caps is roughened by abrasive blasting with aluminum oxide in preparation for intraoral bonding. The caps and the framework are sent to the dental surgeon.

If the Ankylos SynCone abutments are selected in the dental laboratory, remove these from the model using the transfer key and also send them to the dental practice.

## Step-by-step: Finishing and delivery of the prosthesis

After intraoral bonding of the tapered caps and the metal framework, the dentist is to perform a bite registration and produce an overall impression for transferring the framework position in the patient's mouth. Both are sent to the dental laboratory together with the metal framework bonded to the caps.

The SynCone abutments always remain in the patient's mouth. The existing prosthesis should be ground out in the area of the abutments now remaining in the patient's mouth and adapted to the altered situation using non-hardening relining material.

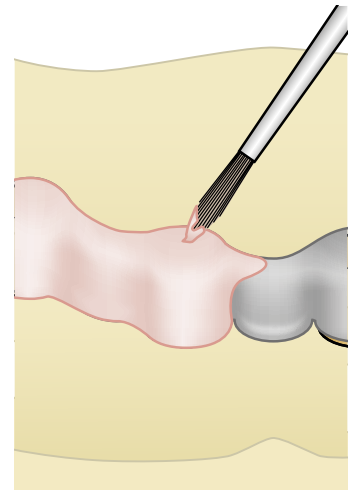
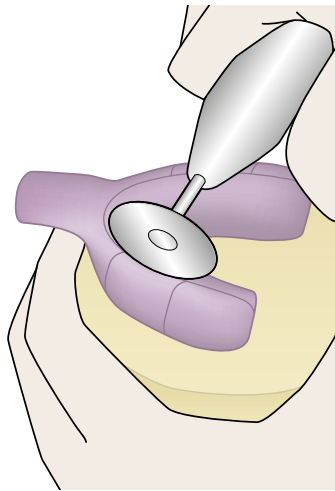
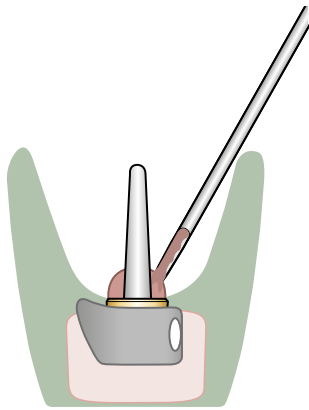

### Casting the model

The dental laboratory creates a model from the overall impression sent by the dental practice, showing the exact position of the intraorally bonded metal framework in the patient's mouth. To fabricate the model, first insulate the Ankylos SynCone caps, fill these with self-curing liquid plastic and provide with a dowel pin. Then fill the impression with dental stone.

### Dividing the tray

The tray must not be removed as usual after the stone has hardened, as this may cause the framework to bend. Instead, the synthetic tray is divided into segments and the impression is removed from the model and framework in sections.

### Opaquing the framework

Pink opaquer is applied to the framework to complete the prosthesis.

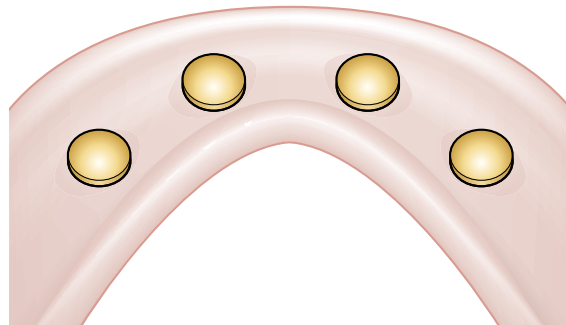
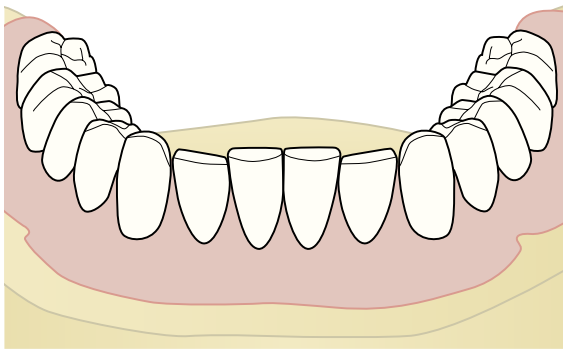
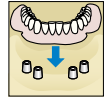

### Completing the prosthesis

Position the teeth and after fitting, finish the prosthesis with cold-curing resin. The prosthesis cannot be finished with hot-curing resin due to temperature development and the changes in position of the caps this may cause.

After completion, inspect the interior of the caps for any excess synthetic sprue. This is removed if present.

Since the prosthesis is now mounted purely on implants, the margins of the prosthesis are shortened as far as possible. The prosthesis can be designed similar to a bridge as there is no longer any soft tissue support. However, all margins need to be sealed. A maxillary prosthesis can be designed without a palate.

The finished prosthesis is sent to the dental practice for delivery on the Ankylos SynCone abutments already located in the patient's mouth.

# Snap Attachment

## Overdentures on Ankylos<sup>®</sup> Snap Attachments C/

Ankylos Snap Attachments C/ are used to attach overdentures in the edentulous mandible simply and economically.

An existing prosthesis can be directly attached at the chairside or an overdenture is fabricated in the laboratory.

Ankylos Snap Attachments are available with tapered implant connection geometry only.



Mandibular prosthesis on two Ankylos Snap Attachments C/

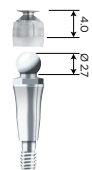

Ankylos Snap Attachment C/ with matrix



Ankylos Implant Analog for Snap Attachment

### Prosthetic components for Ankylos Snap Attachment C/

Ankylos Snap Attachments are laser marked according to their use with the “C/” for “Cone” marking.

Snap attachments allow for compensation of divergences up to 20°.

### Casting the model

#### Ankylos Implant Analog for Snap Attachment

- Replica of the position of the attachment head and the hex of the original abutment in the cast

### Fabricating the suprastructure

#### Ankylos Matrix for Snap Attachment

- For attaching the prosthesis to the snap attachments incorporated in the mouth
- Manufactured from Permador precious metal alloy

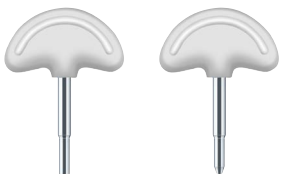
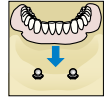

Activator and deactivator for Ankylos Snap Attachment C/

## Instruments

### Activator / Deactivator

- For adjusting the prosthesis seat of prostheses mounted on snap attachments
- Increases or reduces the friction of the Ankylos Snap Attachment C/ matrix

# Step-by-step: Overdentures on Ankylos® Snap Attachments C/

Attaching an overdenture on two implants in the mandible by means of the snap attachment is a very straightforward and economical restoration option for edentulous patients.

The impression for a restoration fabricated in the laboratory is made directly using the attachment head. The laboratory is given the impression without the snap attachment.

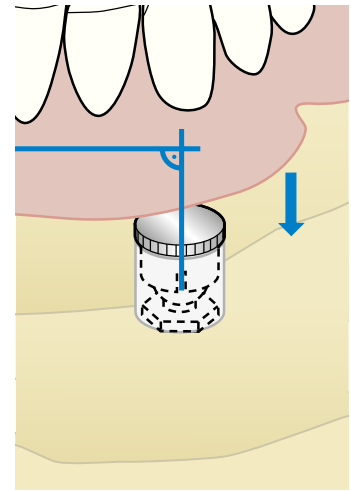
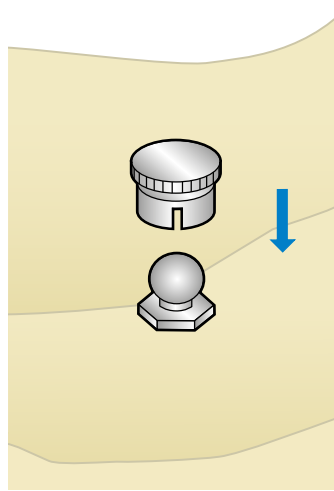
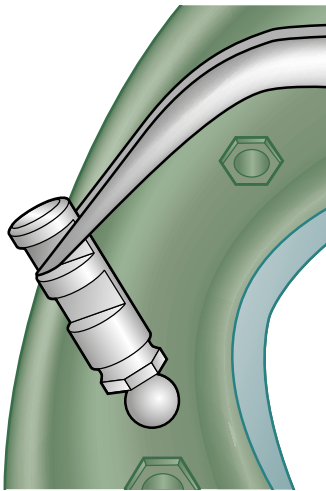

## Inserting implant analog

Position the Ankylos implant analog for the snap attachment directly in the impression and check that the fit is firm.

The Ankylos implant analog for the snap attachment features a hex and an attachment head corresponding with the original abutment and has a stable retention region for anchorage in the stone model.

## Casting the model

Fill the impression with dental stone class IV. The implant analogs for snap attachments are a one-piece units and are not designed to be removed from the cast.

## Assembling the prosthesis

Attach the Ankylos matrices for snap attachments to the implant analog as a placeholder and prepare the prosthesis as for a complete denture. The prosthesis try-in, however, is made without the matrices.

## Polymerizing the matrices

Position the Ankylos matrices for the snap attachments on the abutment. The attached silicone ring grips the hex of the snap attachment abutment at its bottom end and envelops the lamellae of the matrix at its top end. Hence, the silicone ring retains the matrix in axial alignment with the abutment.

The snap attachments are secured in the prosthesis using cold- or hot-curing resin. Ensure that no synthetic material makes its way between the lamellae. Observe the manufacturer's directions for the polymerize.



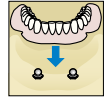

Only the activator or deactivator should be used to adjust the friction. Never bend the matrix lamellae individually with a blade or similar. The resulting uneven strain will cause matrix breakage.

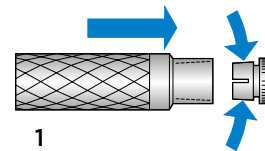
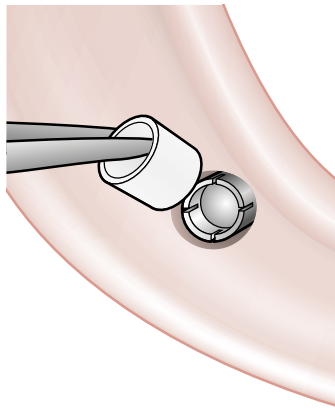
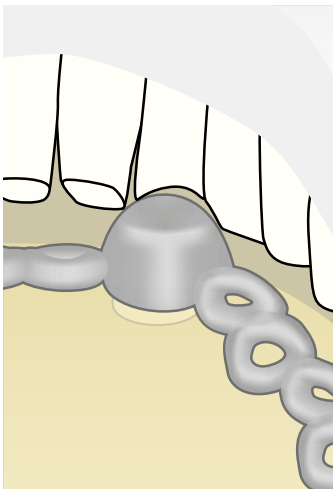

1

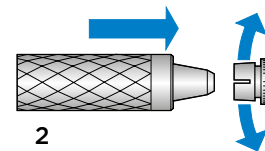

2

Delicate prostheses can be weakened by the integration of the snap attachment matrix. In these cases, a customized lingual plate or an inserted model cast framework will ensure the durability of the prosthesis.

Remove the silicone ring after polymerization and check the movement of the activator.

The elaborated prosthesis, once finished, should be delivered to the practice for fitting.

Should the prosthesis be seated too firmly or too loosely on the snap attachments, the friction of the matrix lamellae can be adjusted using the activator or deactivator.

**Activate (1):** The inner cone of the instrument grips around the lamellae, compresses these and hence ensures an increased friction. The prosthesis fits more firmly.

**Deactivate (2):** The conical side of the instrument pushes the lamellae apart and hence ensures a decreased friction. The prosthesis fits less firmly.

# Standard C/

The Ankylos Standard C/ prosthetics range is an option for straightforward and economical reconstruction of edentulous gaps, free ends and edentulous jaws with single crowns, bridges and bar-supported prostheses.

Ankylos Standard C/ prosthetic abutments are only available with the tapered connection geometry without indexing.

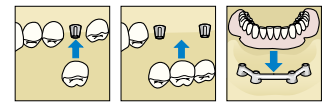

# Crowns, bridges and bar-supported overdentures on Ankylos<sup>®</sup> Standard C/

Ankylos Standard C/ prosthetic abutments are selected and incorporated right after contouring the gingiva, directly at the chairside. After this, the abutments remain in the patient's mouth.

## Ankylos Standard C/ abutment

- Not changing abutment components means simplified handling and optimal patient comfort
- The impression of the abutment position for the laboratory is taken via the cap
- Straightforward provision of a temporary denture for the patient



1-5 | Laterally screw-retained crown on Ankylos Standard C/.

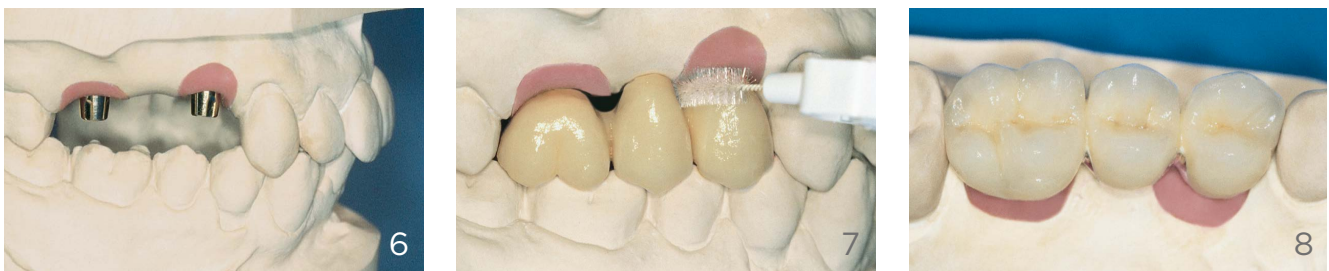

6-8 | Bridge on two Ankylos Standard C/ abutments (Dentsply Sirona Implants).

# Prosthetic components Ankylos® Standard C/

All Ankylos Standard C/ components are laser marked according to their use with the "C/" for "Cone" marking.



Ankylos Standard C/ abutment, straight, diameter a (above) and b (below)



Ankylos Standard C/ abutment, angled, diameter a (above) and b (below)

Gingival heights

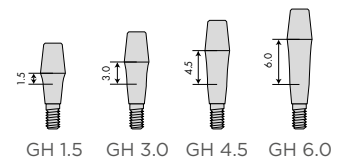

Dimensions Ankylos Standard C/ abutment [mm]

## Prosthetic abutments

Ankylos Standard C/ abutments are selected and incorporated prior to taking the impression at the chairside. After impression taking, the abutments remain in the patient's mouth.

### Ankylos Standard C/ Abutments, straight

- Two diameters (a, 3.3 mm, and b, 4.5 mm), four gingival heights (1.5, 3.0, 4.5 and 6.0 mm) and two abutment heights (4.0 and 6.0 mm) allow great flexibility
- One-piece with integrated thread
- Chairside abutment selection; the abutments remain in the patient's mouth
- Simplified supragingival impression taking and try-in of framework
- Cemented or occlusally screw-retained
- Titanium alloy, Ti6Al4V

### Ankylos Standard C/ Abutments, angled

- Angulation 15°; two diameters (a, 3.3 mm, and b, 4.5 mm), two gingival heights (1.5 and 3.0 mm) and two abutment heights (4.0 and 6.0 mm) allow great flexibility
- One-piece with straining screw
- Cemented or laterally screw-retained
- Titanium alloy, Ti6Al4V

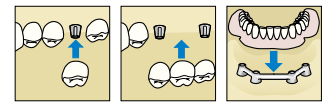

Head diameter

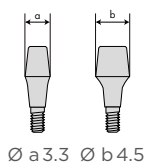

Angulations and head heights

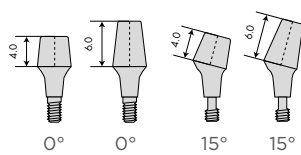

Ankylos Standard transfer caps

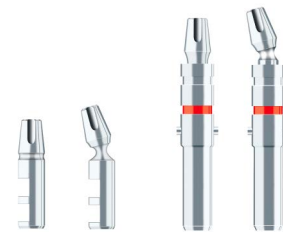

Ankylos Standard laboratory analogs, one-piece (left) and two-piece (right)

## Impressions

### Ankylos Standard Transfer Cap

- For transferring the position of the prosthetic abutment to the master cast
- Attachment to the abutment by retention, on straight abutments also using the wax-up screw, long, order no. 3104 5213 (impression with open tray)
- Color coding according to the abutment diameter and height

## Model fabrication

### Ankylos Standard Laboratory Analog

- Placeholder for the implant and the original abutment remaining in the patient's mouth in the master cast
- Straight and angled, according to the abutment geometry
- One-piece
- Also optionally as a two-piece analog sleeve with pluggable abutment analog

# Prosthetic components Ankylos® Standard C/

Various prefabricated caps are available for the laboratory for straightforward fabrication of crowns, bridges and bar-supported prostheses on Ankylos Standard C/ abutments.



Ankylos Standard wax-up copings for single crowns (white, above) and bridges (gray, below)



Ankylos Standard Degunorm gold copings



Ankylos Fixation Screws

## Prosthetic restoration

### Ankylos Standard Wax-up Coping

- For modeling crowns and bridges for straight and angled Standard C/ abutments
- Occlusal and lateral holes for screw-retained suprastructures
- Also for cemented suprastructures
- Wax-up copings for single crowns (white), ribs for rotation locking

Both wax-up copings are manufactured from POM and are attached, where required, with the M 1.6 mm occlusal hexagon retaining screw (order no. 3105 6021) or M 1 x 0.2 lateral hex retaining screw (order no. 3105 6051). Screws must be ordered separately.

### Ankylos Standard Gold Coping Degunorm

- For fabricating soldered bar restorations on straight Standard abutments
- High-gold content Degunorm precious metal alloy
- M 1.6 occlusal hexagon retaining screw included

### Ankylos screw for wax-up

- For attaching the wax-up copings on the Ankylos Standard C/ laboratory analog during fabrication of screw-retained suprastructures

### Ankylos M 1.6 Occlusal Hexagon Retaining Screw

- For attaching occlusally screw-retained crowns and bridges on Standard C/ abutments
- For attaching the Degunorm gold copings
- Order no. 3105 6022, 3105 6025 or 3105 6026

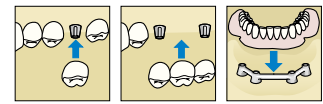

Ankylos M 1 x 0.2 lateral hexagon retaining screw with sleeve for retaining screw lateral hexagon

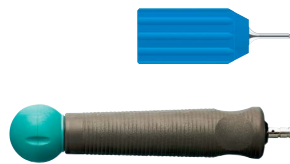

Ankylos 1.0 mm hex laboratory screwdriver (above) and handle for easier handling of the prosthetic components



Ankylos Finisher

### Ankylos M 1 x 0.2 Lateral Hexagon Retaining Screw

- For attaching laterally screw-retained crowns and bridges on Standard C/ abutments
- Order no. 3105 6051
- Cast on Permador sleeve for retaining screw lateral hexagon available (Order no. 3105 6052)

### Instruments

#### Ankylos Laboratory Hex Screwdriver 1.0 mm

- For inserting the 1.6 mm occlusal hexagon retaining screw and the lateral retaining screw
- Reduced torque: 10 Ncm

#### Ankylos Handle for Abutment Analogs and Abutments

- For improved management of the prosthetic components during laboratory processing
- A second analog is used when using one-piece laboratory analogs
- Prevents damaging the model

#### Ankylos 1.6 mm Blade Screwdriver Insert

- For inserting the wax-up screw
- Used with the handle for screwdriver

#### Ankylos Finisher

- For elaborating the prosthetic restoration
- Ankylos finisher for tapered occlusal retention screw and finisher for taper lateral retention screw for polishing the occlusal or lateral screw channel

# Step-by-step: Fabricating the model for purely implant-supported restorations

The impression for suprastructures on Ankylos Standard C/ abutments is taken using an Ankylos Standard transfer cap over the Ankylos Standard C/ abutments already incorporated in the patient's mouth. By doing so, the abutment position is transferred.

The abutments remain in the mouth after the impression is taken using the repositioning technique. On straight abutments, an open tray impression can be taken as well, using the wax-up screw, long.

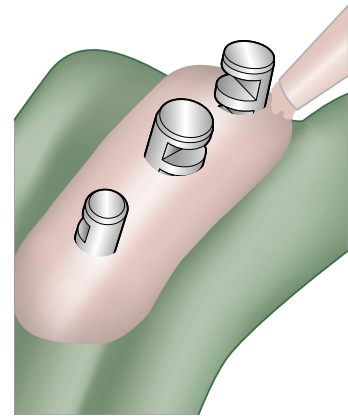
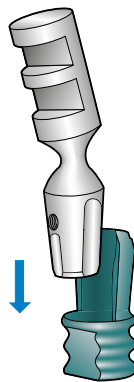
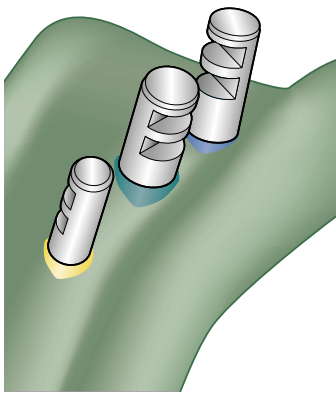

## Repositioning of one-piece laboratory analogs

Position the Ankylos Standard laboratory analog in the transfer cap and check for a firm fit.

## Angled laboratory analogs

Angled Ankylos Standard C/ abutments feature a shortened groove for transferring the alignment of the 15° angle. The position of this groove in the transfer cap should be observed when inserting the laboratory analog.

## Mucosa mask

Insulate with silicone lubricant and inject gingiva casting material into the impression prior to casting. By doing so, observe the manufacturer's directions.

Block the undercut neck area with wax prior to fabricating the model without a mucosa mask.



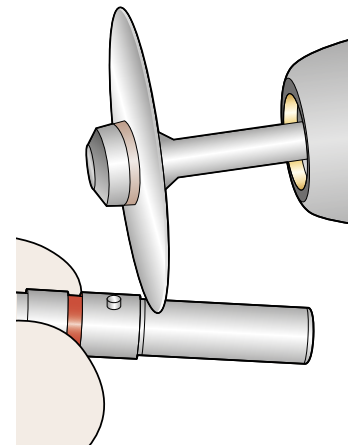
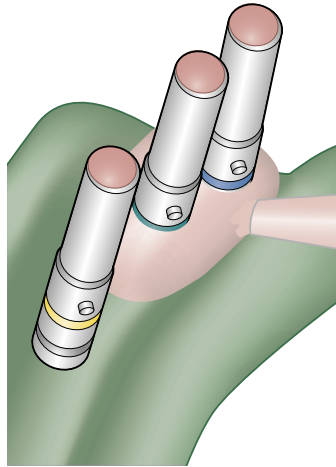
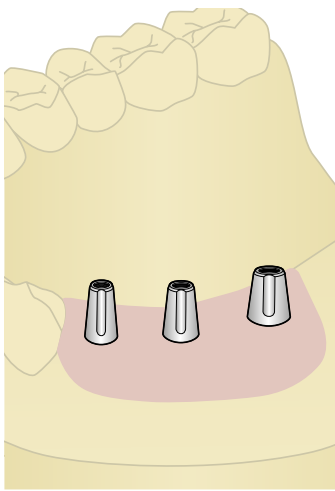
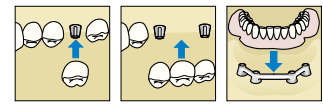

### Model

The geometry and the occlusal or lateral thread of the laboratory analog match the original abutments in the patient's mouth.

Please now continue with fabricating the bridge, as described on page 91.

### Option: Two-piece laboratory analogs

As an alternative, two-piece laboratory analogs can also be used.

To protect the underside of the analog sleeve, seal this against incoming plaster with wax. The open sleeve allows simple cleaning.

### Shortening two-piece laboratory analogs

For fabricating a saw-cut model, the analog sleeves can be shortened as far as the indentation.

# Step-by-step: Fabricating the model for tooth-/implant-supported restorations

Ankylos Standard C/ abutments enable the incorporation of prepared teeth into the suprastructure. Here, the following directions for fabricating the model should be observed.

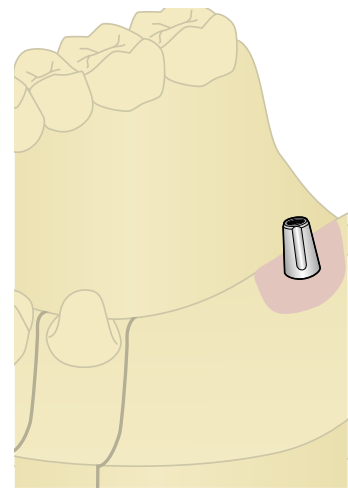
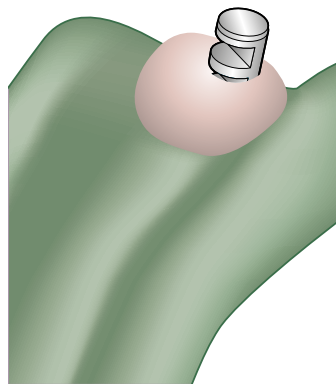
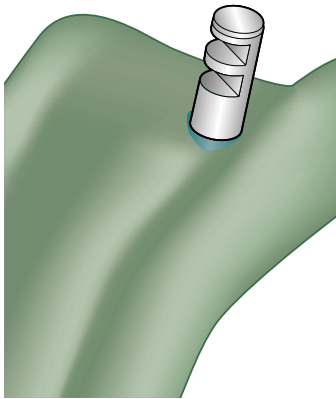

## Repositioning the laboratory analog (one-piece or two-piece)

Position the Ankylos Standard laboratory analog in the transfer cap and check for a firm fit. Dowel pins or arched pins should be mounted in the area of the prepared teeth and other alveolar ridge sections or the fabrication process for a model with a synthetic base plate should be followed.

## Mucosa mask

Insulate the impression with silicone lubricant and coat the laboratory analog with gingiva casting material prior to casting. By doing so, observe the manufacturer's directions.

Cover the dental arch with dental stone class IV. By doing so, ensure an adequate height, such that the laboratory analog is covered with plaster.

In case pins are introduced subsequently, the dental arch should be trimmed, drilled and the pins should be cemented in.

## Sawing the model

Mount the dental arch on a plaster base and saw the model. Prepared tooth stumps should be so constructed as to be removable.

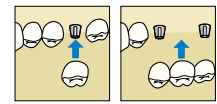

# Step-by-step: Crown or bridge, cemented

Implant-supported crowns and bridges on Ankylos Standard C/ abutments can both be cemented and screw-retained. The fabrication of the suprastructure is shown using the example of the restoration of an

edentulous gap with a bridge. The same steps are performed in the procedure for fabricating a single crown.

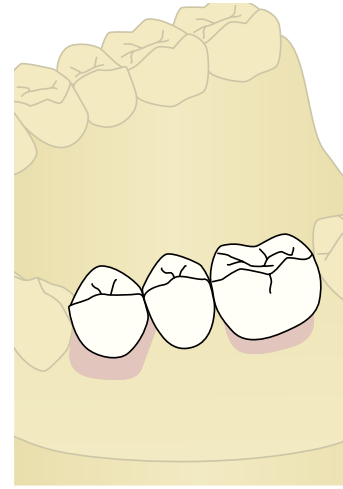
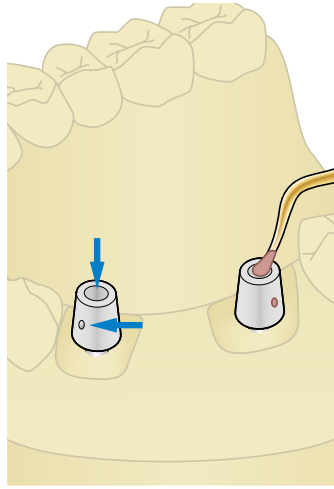
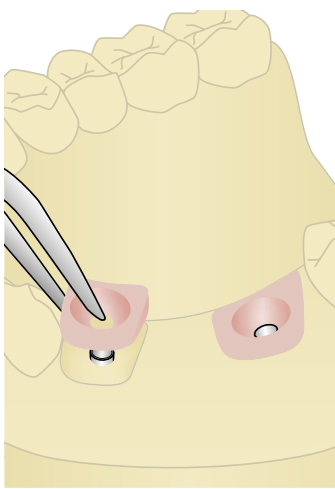

## Assembling the models in the articulator

Assemble the models by means of assembling the impression in the articulator as it would be positioned in the patient's skull.

### Remove mucosa mask

Remove the mucosa mask in order to have an unobstructed view of the structure of the crown margins.

## Attaching the wax-up copings

Attach suitably sized Ankylos Standard wax-up copings for bridges. Depending on the axial alignment, the wax-up copings for bridges (grey) without internal ribs are used. This can have advantages for the insertion alignment.

Wax-up copings with ribs for rotational locking (white) are available for fabricating single crowns.

## Cemented suprastructure

Seal both holes in the wax-up copings with wax.

Wax up the bridge as usual. The framework is fabricated and veneered in accordance with the current dental method for metal-ceramic or full-ceramic suprastructures.

The occlusion is designed according to the "freedom in centric" principle. A purely incisal / cuspid guidance should be aimed for in lateral movements. Check the interdental spaces after the veneering for hygienic capability.

# Step-by-step: Crown or bridge, occlusally screw-retained

Suprastructures are screw-retained occlusally on straight Ankylos Standard C/ abutments, and laterally on angled abutments.

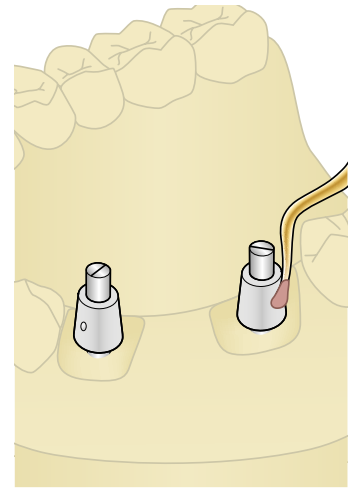
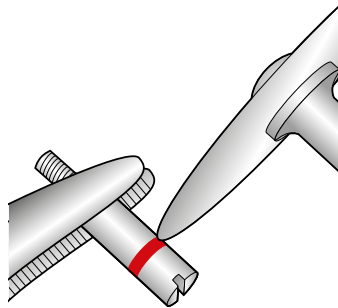
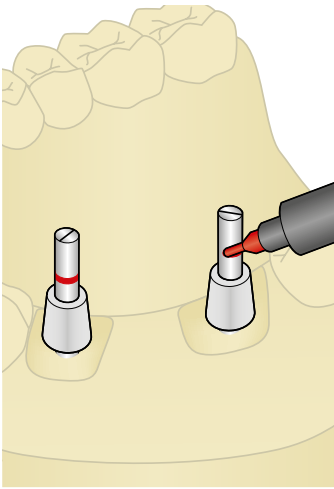

## Screw-retained suprastructure

Mount the wax-up copings with wax-up screws (order no. 3104 5211/short or 3104 5213/long) and mark the required length.

Shorten the wax-up screws corresponding to the occlusal proportions and, using a thin cutting disk, make a new slot. Then fix these in the laboratory analogs.

Depending on the screw-retention type, seal the hole not required with wax. By doing so, ensure that no wax gets into the inside of the copings.

These directions show the fabrication of an occlusally screw-retained bridge. If lateral screw-retention is planned, please observe the directions on page 94/95.

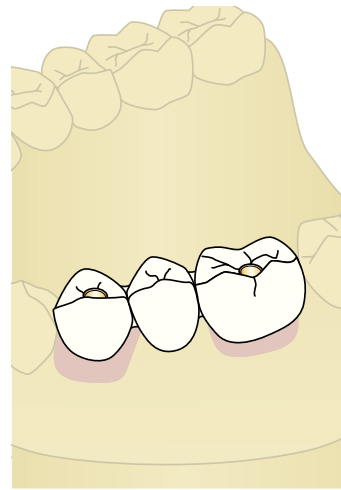
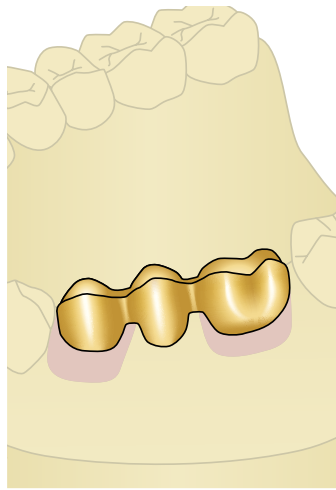
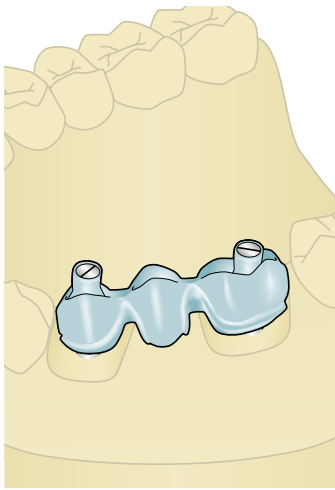
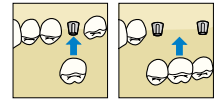

Wax up the bridge framework and create a cylindrical channel for the later retaining screw by using the wax-up screw. Adequately dimensioned interdental spaces should be ensured. If the wax-up copings are bonded with synthetic material, they must be roughened beforehand.

Invest the wax-up as usual. Too small an investment compound expansion should not be selected in this process, in order to avoid a frictional fit.

After molding, deinvesting and abrasion, the framework is fitted on the model where the occlusion is simultaneously checked.

The screw seating can be occlusally reworked for the taper with the Ankylos finisher.

The wax-up screw is used to protect the screw channel while the ceramic material is applied.

The completed suprastructure is sent to the practice for delivery. Where crowns or bridges are occlusally screw-retained, the screw holes are covered with wax or gutta-percha and sealed with composite after incorporation.

## Step-by-step: Crown or bridge, laterally screw-retained

The following example shows the somewhat more elaborate fabrication of a laterally screw-retained single tooth restoration on an angled Ankylos Standard C/ abutment. Where straight abutments with occlusal screw retention are used, proceed to the description on page 92/93 (bridge).

As a rule, single crowns are cemented on the abutments. In this case, the procedure also corresponds with that for fabricating bridges.

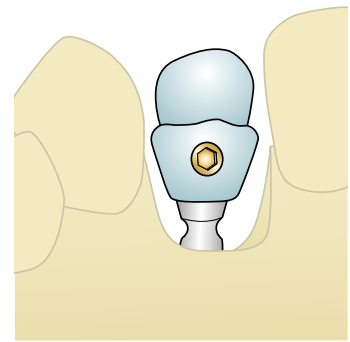
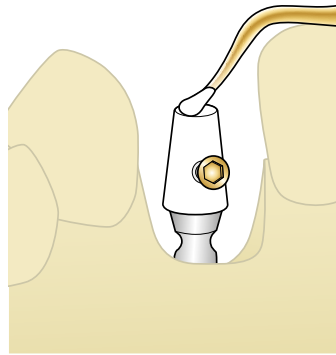
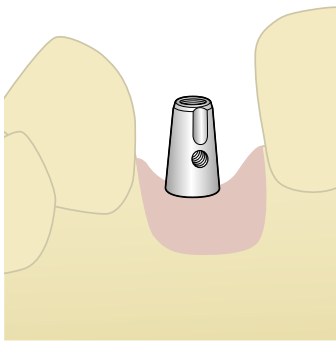

### Fabricating the model

Fabricate the model for the single-tooth restoration with an angled abutment and mucosa mask, as described on page 90/91.

### Wax-up coping and lateral retaining screw

Remove the mucosa mask and attach the wax-up coping for single crowns (white). Seal the occlusal hole in the coping not required with wax. Insert the gold-colored Ankylos M 1 x 0.2 lateral hexagon retaining screw (order no. 3105 6051) - if preferred, with the sleeve for lateral retaining screw.

The lateral screw and, if necessary, the sleeve should be well covered with wax.

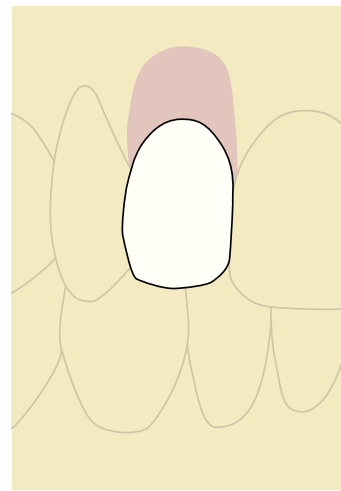
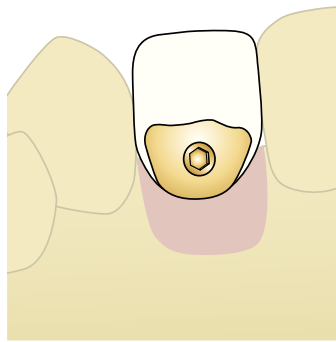
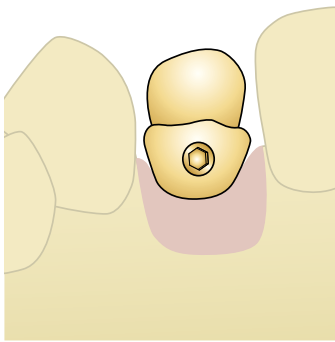
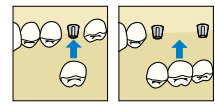

### **Fabricating the model and the framework**

Waxing up and fabricating the framework are in accordance with the current dental method. Observe the processing directions for cast-on sections for dental alloys during waxing.

For angled abutments, the screw seat can be laterally reworked with the finisher.

### **Veneering**

Veneer and polish the crown as usual. Interdental spaces are designed for hygienic capability. The occlusal contact should be only minimal. Lateral contact points should be avoided.

## Step-by-step: Bar restoration (laser-welded or soldered)

The Ankylos Standard C/ prosthetics range also enables the straightforward fabrication of removable overdentures on bars.

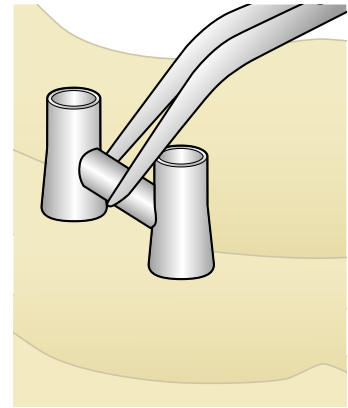
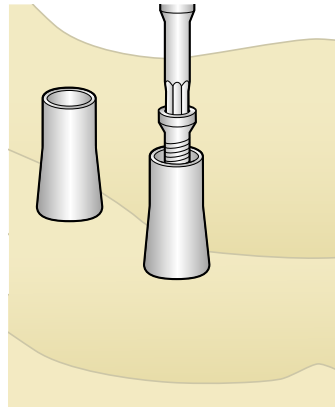
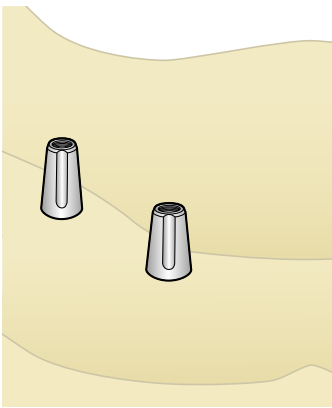

### Fabricating the model

Fabricate the model with Ankylos Standard implant analogs as described on page 90/91.

### Attaching the gold copings

Depending on the scheduled processing technique, attach Ankylos Standard Degunorm gold copings on the abutments and fix with the suitable occlusal screw (M 1.6 occlusal hexagon retaining screw, order no. 3105 6021).

### Adjusting the Bars

Fit the bars into the spaces between the gold copings. Keep the gaps between the bar and the gold copings as narrow as possible.



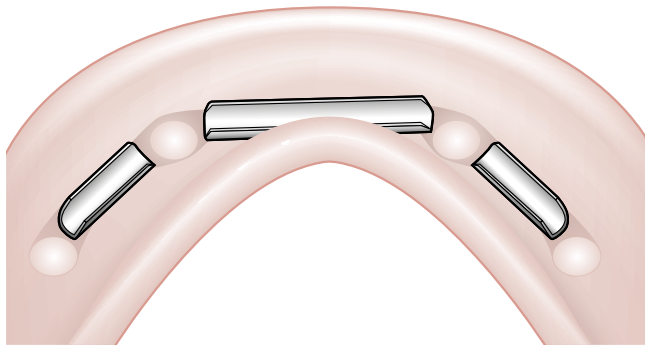
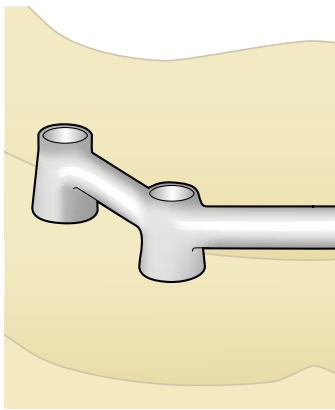
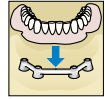

### **Bar - laser-welded or soldered**

Laser-welded or soldered bars are fabricated as described on pages 45 ff, for the Ankylos Balance Base Abutment. Likewise, the fabrication of the prosthesis.

## Appendix

### SmartFix concept

With the SmartFix treatment concept patients can benefit from an immediate implant-supported restoration, as a temporary prosthesis is screwed onto the implants on the day of surgery. Final solutions for the SmartFix treatment concept include both fixed prostheses and removable solutions e.g. Atlantis patient-specific suprastructures.

[For further information and step-by-step procedures refer to SmartFix concept manual.](#)



### Acuris conometric concept

Acuris is a paradigm shift in prosthetic retention of single crowns that are fixed yet retrievable by the clinician. The friction-based retention offers a fixation mode providing the esthetics of a cement-retained crown, maintaining retrievability and excluding the risk of submucosal residual cement.

[For further information and step-by-step procedures refer to Acuris conometric concept manual.](#)



### WeldOne concept

The WeldOne concept provides a stable framework with a passive fit for immediate restorations, as temporary or durable prostheses, at the same day as the surgery.

[For further information and step-by-step procedures refer to WeldOne concept manual.](#)

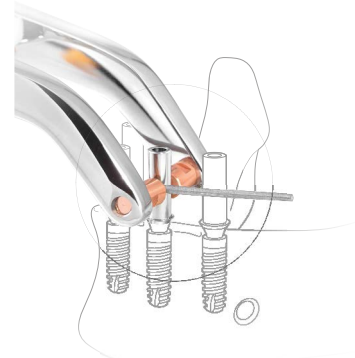

## Cleaning and sterilization instructions

Products within DS Implants are designed to be cleaned and sterilized before clinical use with the exception of sterile products. The cleaning and sterilization instructions have been developed and validated by Dentsply Sirona in accordance with the applicable standards.

[For further information and step-by-step procedures refer to the Cleaning and sterilization instruction. For products with alternative legal manufacturer see respective product's IFU.](#)

### LOCATOR R-Tx® concept

[For full product assortment and step-by step procedures refer to www.zestdent.com](http://www.zestdent.com) for more information.

# Notes

---

THE DENTAL  
SOLUTIONS  
COMPANY™

